



LEGAR

CATALOGO
GENERALE

2026 — 2027

Le riproduzioni fotografiche, i colori, le caratteristiche proposte su questo catalogo possono non corrispondere esattamente alle versioni commercializzate. Ci riserviamo il diritto di apportare modifiche agli articoli senza alcun obbligo di preavviso alla clientela. E' vietata la riproduzione anche parziale del presente catalogo senza specifica autorizzazione della Legar Sport.





ORDINI CLIENTI
clienti@legar.it



WEB
www.legarshop.it

**Inquadra questo codice
per visualizzare e scaricare
il catalogo in PDF
oppure
scaricare le schede tecniche**

SCAN ME





TEAM BAGS



Merce voluminosa, trasporto al costo



Pezzi per confezione - obbligo acquisto



Gli ordini effettuati sul B2B: www.legarshop.it
hanno la precedenza sugli ordini ricevuti via mail/whatsapp
NON si accettano ordini telefonici

A			
ATLETICA	110	CINTURE FLAG RUGBY	107
AGHI	45	CLAVETTE RITMICA	108
ANTENNE VOLLEY	96	CLIP	30
ARCO DI PRECISIONE	42	COMPRESSORI	45
ARREDAMENTO SPOGLIATOIO	126	CONI	34
ASTE	30	CONTAMETRI	111
ATTREZZO SUSPENSION	66	CONTENITORI PORTA PALLONI	44
B		CORDA ELASTICA RESISTENZA	68
BADMINTON	116	CORDE RITMICA	108
BANDE RESISTENZA	69	CORDE SALTO	67
BANDIERINE CORNER	32	CORDONCINI ARBITRO	49
BANDIERINE GUARDALINEE	50	CORNER	32
BARELLA	137	CREME MASSAGGIO E VARIE	136
BARRIERE	39	CRONOMETRI	48
BASI PER PALETTI	31	CUFFIE ACRILICO	19
BASKET	100	D	
BEACH SOCCER	99	DELIMITATORI	35
BEACH VOLLEY	99	DEODORANTE SCARPE	75
BERMUDA MICROFIBRA	20	DEPILAZIONE	136
BERSAGLI TIRI DI PRECISIONE	41	DISCHI GHISA	65
BERRETTO	19	DISCHI LANCIO	112
BILANCIERE	65	DISCHI PIATTI	35
BLOCCHI CAMBIO GIOCATORI	53	DISPENSER	135
BLOCCHI PARTENZA	110	DODGEBALL	123
BORCHIE	78	E	
BORRACCE	46	ELASTICI	70
BORSE	6	ELASTICI RESISTENZA	68
BORSE MEDICHE	13	F	
BORSA ZAVORRA	85	FARMACEUTICA	130
BORSE PORTA PALLONI	14	FASCE CAPITANO	51
BORSE PORTAMUTE	12	FASCE LUTTO	51
C		FASCIA PER CAPELLI	19
CALCIO TENNIS	42	FISCHIETTI ARBITRO	49
CALZE	21	FODERE MATERASSI	114
CALZONCINI	16	FONDI	15
CANESTRI BASKET	100	FORCA ALLENAMENTO GIOCO TESTA	40
CANOTTE BASKET	19	FRATINI	17
CAPPELLINI ACRILICO	19	FRECCE BASKET	103
CARRELLI PORTAPALLONI	44	FRISBEE	123
CARRELLI SEGNACAMPO	80	G	
CARTELLINI ARBITRO	50	GANCI REGGIRETE	89
CASACCHE	17	GHIACCIO Istantaneo E SPRAY	134
CASSETTA MEDICA	131	GRASSO SCARPE	75
CAVIGLIERE	66	GUANTI INVERNALI	19
CERCHI PIATTI	31	GUANTO PALESTRA	65
CERCHI TONDI	109	GUARDALINEE	50
CEROTTI	135	H	
CESTELLO PORTABORRACCE	46	HANDBALL	104
CESTONI PORTA PALLONI	44	HOCKEY	105
CHIODI ATLETICA	76	I	
CINESINI	35	IDROPITTURA	80

IMPIANTI BASKET	102	PALLE GETTO	112
IMPIANTI VOLLEY	97	PALLE GINNICHE	61
IMPIANTO CALCIO TENNIS	42	PALLE MEDICHE	62
K		PALLE RITMICA	108
KETTLEBELL	64	PALLINE PICKLEBALL	118
KINETIC	133	PALLINE PING PONG	117
KIT BASKET	19	PALLONI BASKET	28
KIT CORNER	32	PALLONI CALCIO	22
KIT MEDICALE	131	PALLONI FUTSAL	24
L		PALLONI HANDBALL	26
LACCI SCARPE	75	PALLONI RUGBY	27
LANTERNE ORIENTEERING	121	PALLONI SONORI	29
LAVAGNE TATTICHE	54	PALLONI VOLLEY	25
LAVASCARPE	42	PANCHINE ALLENATORI	82
LETTINO	127	PANCHINE SPOGLIATOIO	126
M		PANNELLO RIMBALZO PALLONE	43
MACCHINE SEGNACAMPO	80	PANTALONCINI	16
MADREVITI SCARPE	78	PANTALONCINI VOLLEY	20
MAGLIE	17	PANTALONCINO PASSEGGIO	20
MAGLIE TERMICHE	18	PANTALONE TERMICO	18
MAGNESIO ANTISCIVOLO	65	PARACADUTE	66
MANOMETRI	45	PARADENTI	107
MANUBRI	64	PAVIMENTAZIONE	127
MATERASSI	114	PEDANE PROPRIOCETTIVE	72
MATERASSI DI PROTEZIONE	124	PESI	65
MATERASSI PORTIERE	40	PETTORINE	17
MATERASSINI	58	PILATES	60
MATERASSO GYM MAT	109	PING PONG	117
MAZZE BASEBALL	122	PLANTARI	74
MEDICALE	130	PLIFIX	80
MEDUSE	72	PLYOBOX	67
MEGAFONO	111	POGGIAPIEDI	127
METRI	111	POMPE	45
MINICOMPRESSORE	45	PORTE CALCIO/CALCETTO	84
MOTRICITA'	121	PORTE HANDBALL	104
N		PORTICINE	94
NASTRO CALZASU	21	PRODOTTI MEDICALI	130
NASTRO RITMICA	109	PROTEZIONI IMPIANTI	124
NASTRI FASCIATURE	130	PROTEZIONI SICUREZZA	124
NUMERI	138	PULISCI SCARPE	42
O		R	
OLIO MASSAGGIO	136	RACCHETTE BADMINTON	116
ORIENTAMENTO	121	RACCHETTE PICKLEBALL	118
OSTACOLI	36	RACCHETTE TENNIS TAVOLO	117
OSTACOLI ATLETICA	110	RETI BASKET	100
P		RETI CALCIO	90
PALCO ARBITRO VOLLEY	98	RETI PICKLEBALL	119
PALETTE BASKET	103	RETI PORTA PALLONI	14
PALETTI SLALOM	30	RETI RECINZIONE CAMPI	93
PALETTI CON PUNTALE	30	RETI RICAMBIO PORTICINE	94

RETI VOLLEY	99
RIBALTINE	88
RICAMBI SPAZZOLE SEGNACAMPO	81
RICAMBI SPAZZOLE LAVASCARPE	42
RITMICA	108
RONDELLE	78
ROTELLA METRICA	111
ROTOLO CARTA	127
RUGBY	106
RUOTA PER ADDOMINALI	66
RUOTE PER PORTE CALCIO	84
S	
SACCA PALESTRA	10
SACCA PER SABBIA	85
SACCHE PORTA PALLONI	14
SAGOME	38
SAGOME GONFIABILI BASKET	102
SAGOME GONFIABILI CALCIO	38
SAGOME GONFIABILI RUGBY	107
SALVAPELLE	130
SCALDACOLLO	19
SCALDINI	137
SCALETTE	33
SCOCCHE	82
SEDUTE	129
SEGNALETICA CAMPO	34
SEGNAPUNTI BASKET	103
SEGNAPUNTI VOLLEY	98
SEGGIOLINI PANCHINE	82
SLACKLINE	73
SLITTE	43
SOLETTE	74
SOSPENSORIO	107
SPAZZOLE	75
SPRAY DEPIPARATORIO	136
STEP	67
STUOIE	58
T	
TABELLA CAMBIO GIOCATORE	53
TABELLA ELETTRONICA	52
TABELLONI BASKET	101
TACCHETTI	76
TALLONIERE	74
TAMPONI NASALI	132
TAPE	130
TAPPETINI POGGIAPIEDI	127
TARTARUGHE	72
TAVOLETTE PROPRIOCETTIVE	73
TELAI PORTIERE	41
TELAIO TCHOUKBALL	41

TENDISCARPE	74
TENNIS	120
TENNIS TAVOLO	117
TENSOPLAST	131
TERMICO	18
TESTIMONI	110
TRALICCIO GIOCO TESTA	40
TRAMPOLINO ELASTICO	43
TRIBUNE	129
V	
VASELINA	74
VERNICE CAMPO	80
VOLANI BADMINTON	116
VOLLEY	96
VORTEX	113
Y	
YOGA	60
Z	
ZAINI	8
ZAINETTO EVERGREEN	10

CATEGORIE

ABBIGLIAMENTO	16
ARBITRO	48
ATLETICA	110
ATTREZZATURA MULTISPORT	30
BASKET	100
BORSE	6
CALCIO	80
FITNESS	58
HANDBALL	104
LAVAGNE	54
MEDICALE	130
PALLONI	22
PROTEZIONI	124
RITMICA	108
RUGBY	106
SCUOLA	121
SPOGLIATOIO	126
SPORT CON RACCHETTA	116
TACCHETTI E ACCESSORI SCARPE	74
VOLLEY	96

6 - borse

COD. SB115 - BORSA BIG

€ 22,40 cad

Capienza totale 83 litri, capienza senza fondo 58 litri
Maniglia con portanome
Tasca frontale
Poly 600 D

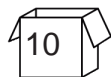

Black
Nero



Green
Verde



Red
Rosso



Burgundy
Granata



Navy
Blu

cm 49



cm 53

cm 32

COD. SB315 - BORSA BIG BICOLORE

€ 22,40 cad

Capienza totale 83 litri, capienza senza fondo 58 litri
Maniglia con portanome
Tasca frontale
Poly 600 D



Navy/Red
Blu/Rosso

cm 49



cm 53

cm 32



BORSA BIG CON FONDO PIEGHEVOLE

COD. SB0190 - NAVY
COD. SB0170 - NERO

€ 27,00 cad

€ 27,00 cad

Capienza totale 83 litri, capienza senza fondo 58 litri
 Maniglia con portanome
 Tasca frontale
 Poly 600 D
 Già incluso fondo pieghevole

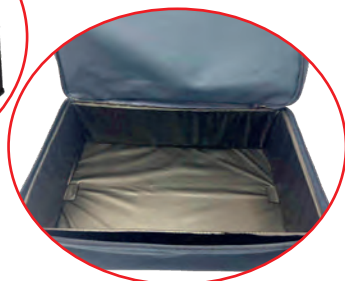

cm 49



Black
 Nero



COD. SB213 - BORSA MEDIUM

€ 21,60 cad

Capienza totale 65 litri, capienza senza fondo 47 litri
 Maniglia con portanome
 Tasca frontale
 Poly 600 D

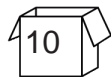

Royal blue
 Royal



Navy
 Blu

cm 46



8 - borse

COD. BP010 - ZAINO BASIK

€ 14,00 cad

Capienza totale 39 litri, capienza senza fondo 30 litri
Tasca interna porta oggetti
Schienale imbottito
Poly 600 D



Navy
Blu



Blue royal
Royal



cm 48

cm 24

cm 34

COD. BP004 - ZAINO SPAIN

€ 17,00 cad

Capienza totale 39 litri, capienza senza fondo 30 litri
Tasca interna porta oggetti
Tasca frontale
Poly 600 D



Black
Nero

cm 47



cm 24

cm 34

Blue navy
Blu



COD. BP002 - ZAINO BICOLORE

€ 15,20 cad

Capienza totale 39 litri, capienza senza fondo 30 litri
 Tasca interna porta oggetti
 Schienale imbottito
 Poly 600 D



Black/Grey
Nero/Grigio



Navy/Red
Blu/Rosso



Navy/Yellow
Blu/Giallo



cm 48

cm 24

cm 34

COD. BP003 - ZAINO PROFIL

€ 15,20 cad

Capienza totale 39 litri, capienza senza fondo 30 litri
 Tasca interna porta oggetti
 Schienale imbottito
 Poly 600 D



Royal blue
Royal



Red
Rosso



Black
Nero



Navy
Blu



cm 48

cm 24

cm 34



10 - borse

COD. BP001 - ZAINO CLASSIC

€ 15,81 cad

Capienza totale 38 litri, capienza senza fondo 29 litri
Tasca interna porta oggetti
Tasca frontale
Cordoncino per chiusura e fibbia
Poly 600 D

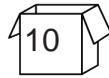

Red
Rosso



Black
Nero



Royal Blue
Royal



Green
Verde



Burgundy
Granata



cm 46

cm 34

cm 24

COD. OPG280 - ZAINETTO EVERGREEN

€ 1,49 cad

cm 33x45 h
PL

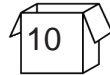

Royal Blue
Royal



White
Bianco



Black
Nero



Navy
Blu



COD. GB006 - BORSA BASKET

€ 29,00 cad

Capienza totale 89 litri
 Maniglia con portanome
 2 tasche laterali molto capienti con retina traspirante
 Tracolla imbottita
 Poly 600 D



Black
Nero



12 - borse

COD. GB001 - BORSA GYM

€ 23,80 cad

Capienza totale 64 litri
Maniglia con portanome
2 tasche laterali di cui una con sacca portascarpe impermeabile e con retina traspirante
Piccola tasca interna porta oggetti
Poly 600 D

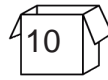

Navy with royal pipping
Blu con profilo royal



Navy with navy pipping
Blu con profilo blu



Red with red pipping
Rosso con profilo rosso



Black with grey pipping
Nero con profilo grigio



Black with black pipping
Nero con profilo nero



Royal with navy pipping
Royal con profilo blu

COD. TH002 - BORSA PORTAMUTE

€ 16,00 cad

Capienza totale 93 litri
Poly 600 D



Black
Nero



cm 41

cm 65

cm 35



COD. MB010 - BORSA MEDICA PROFESSIONALE

€ 22,00 cad

Capienza totale 25 litri
 Con tasche interne per l'inserimento di prodotti medicali
 Tracolla regolabile
 Poly 600 D

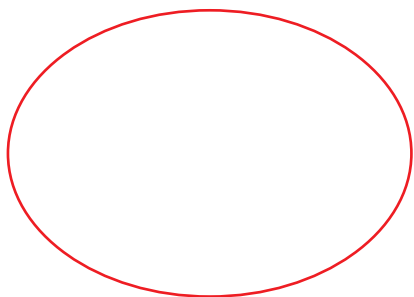

COD. 078114 - BORSA TROLLEY PORTAMUTE

€ 62,97 cad

77 litri
 Poly 600 D, cm 71x34x32 h



COD. MB004 - BORSA MEDICA FIRST AID

€ 10,40 cad

Capienza totale 10 litri
 Tracolla imbottita
 Poly 600 D



14 - borse

COD. 078109 - BORSA PORTA 6 PALLONI GARA

€ 20,43 cad

Capienza 6 palloni
Con maniglie e tracolla per il trasporto
Nylon 600D



COD. 078089 - BORSELLO MULTIFUNZIONE

€ 9,96 cad

Borsello multifunzione da utilizzare come porta scarpe o beautycase
Doppia apertura con cerniera e chiusura a strappo
Cm 35x15x17
Colore nero
Poliestere



COD. 078028 - BORSA PORTA 12/15 PALLONI

€ 23,03 cad

Capienza 12/15 palloni, senza marchio, PI



COD. 078024 - BORSA PORTA 6 PALLONI RUGBY

€ 17,33 cad

Borsa porta pallone da rugby in resistente tela di nylon
Può contenere fino a 6 palloni misura 5
Facile da chiudere grazie al velcro nella clip
Dotata di tracolla per un facile trasporto
Colore nero
Dimensioni: 115x32 cm



COD. 411700 - RETE PORTA 18 PALLONI

€ 6,72 cad

Capienza 18 palloni, PE

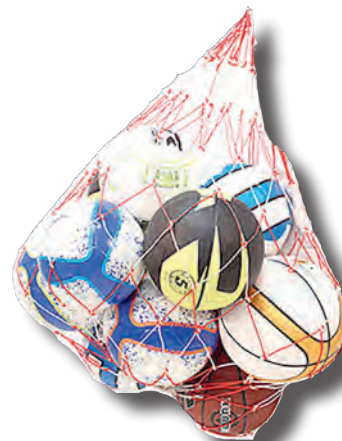

COD. 078034 - RETE PORTA 3 PALLONI

€ 5,27 cad

Capienza 3 palloni da gara, PP



COD. F1506 - FONDO PER BORSA GRANDE

€ 4,20 cad

Fondo rigido in PP per borse modello grande



COD. F1130 - FONDO PER BORSA MEDIA

€ 4,10 cad

Fondo rigido in PP per borse modello medio



COD. F1116 - FONDO PER ZAINI

€ 2,70 cad

Fondo rigido in PP per zaini



16 - abbigliamento

COD. A53001 - PANTA CLASSIC NAVY

€ 4,20 cad

Tessuto in poliestere a 4 pannelli, cordoncino in vita
Da 3XS a 2XL



COD. A53005 - PANTA CLASSIC ROSSO

€ 4,20 cad

Tessuto in poliestere a 4 pannelli, cordoncino in vita
Da 3XS a 2XL



COD. A53007 - PANTA CLASSIC VERDE

€ 4,20 cad

Tessuto in poliestere a 4 pannelli, cordoncino in vita
Da 3XS a 2XL



COD. A53008 - PANTA CLASSIC GRANATA

€ 4,20 cad

Tessuto in poliestere a 4 pannelli, cordoncino in vita
Da 3XS a 2XL



COD. A53003 - PANTA CLASSIC NERO

€ 4,20 cad

Tessuto in poliestere a 4 pannelli, cordoncino in vita
Da 3XS a 2XL



COD. A53002 - PANTA CLASSIC ROYAL

€ 4,20 cad

Tessuto in poliestere a 4 pannelli, cordoncino in vita
Da 3XS a 2XL



COD. A53004 - PANTA CLASSIC BIANCO

€ 4,20 cad

Tessuto in poliestere a 4 pannelli, cordoncino in vita
Da 3XS a 2XL



COD. 206002 - CASACCA BIB

€ 3,68 cad

Casacca in polistere a tessuto liscio
Misura MAN 54x64 h
Misura BOY 46x52 h

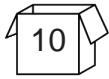

COD. 063209 - CASACCA TRAINING

€ 4,31 cad

Casacca in polistere a tessuto traforato
Misura ADULT 60x76 h
Misura JUNIOR 55x66 h
Misura KID 48x56 H
Misura MINI 40x48 H



COD. 231123 - CASACCA DOUBLE REVERSIBILE

€ 7,88 cad

Casacca in polistere a tessuto liscio, reversibile
Misura MAN 54x64 h
Misura BOY 46x52 h

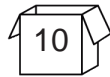

COD. 063310 - CASACCA RUGBY REVERSIBILE

€ 16,15 cad

Casacca in polistere a tessuto liscio resistente ed elastico, con cuciture rinforzate
Misura MAN 64x82 h
Misura BOY 61x75 h



COD. 137200 - MAGLIA BIS

€ 14,48 cad

Maglia a manica corta, esterno lana e interno cotone
Da S a 2XL



COD. 069209 - ANELLO PORTA CASACCHE

€ 3,99 cad

Anello in PVC flessibile e molto resistente per il trasporto e stoccaggio delle casacche, ø 14,5 cm

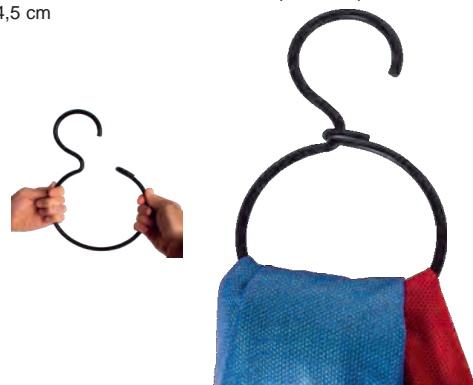

18 - abbigliamento

MAGLIA TERMICA ENERGY NERO

COD. 260413 - LUPETTO MAN

€ 20,52 cad

COD. 260501 - LUPETTO KID

€ 19,86 cad

Maglia termica lupetto progettata per temperature tra +5° e +20° per offrire un isolamento termico ottimale senza compromettere la libertà di movimento

Realizzata in filato SoftAir+

Allontana il sudore dalla pelle mantenendola asciutta e calda anche durante l'attività fisica più intensa

Vestibilità aderente per garantire comfort e massima libertà di movimento

Trattamento antibatterico e antiodore resistente ai lavaggi

64% poliestere

36% poliammide

Misura MAN: S/M - L/XL - 2XL

Misura KID: anni 5/9 - 10/14

PANTA TERMICO ENERGY NERO

COD. 260618 - LEGGING MAN

€ 17,02 cad

COD. 260502 - LEGGING KID

€ 15,61 cad

Panta termico progettato per temperature tra +5° e +20° per offrire un isolamento termico ottimale senza compromettere la libertà di movimento

Realizzata in filato SoftAir+

Allontana il sudore dalla pelle mantenendola asciutta e calda anche durante l'attività fisica più intensa

Vestibilità aderente per garantire comfort e massima libertà di movimento

Trattamento antibatterico e antiodore resistente ai lavaggi

70% poliestere

20% poliammide

10% elasthan

Misura MAN: S/M - L/XL - 2XL

Misura KID: anni 5/9 - 10/14



KIT BASKET DOUBLE

- COD. ABK124** - ROYAL/BIANCO € 23,00 kit
- COD. ABK114** - NAVY/BIANCO € 23,00 kit
- COD. ABK154** - ROSSO/BIANCO € 23,00 kit
- COD. ABK134** - NERO/BIANCO € 23,00 kit
- COD. ABK174** - VERDE/BIANCO € 23,00 kit

Tessuto microforato in poliestere, reversibile, pantaloncino con laccio in vita
Taglie da YS a 2XL



81



41



91



71



61

COD. 21GU03 - GUANTO POINT

€ 4,05 paio

Guanto elasticizzato 100% acrilico con gommatura antiscivolo
MAN
BOY



09

07

COD. 120961 - CUFFIA DOUBLE

€ 3,96 cad

Cuffia in acrilico con maglia pesante a doppio strato
Taglia unica



09

07

COD. 21SC01 - SCALDACOLLO

€ 3,15 cad

Scaldacollo in poliestere, trasformabile in cappellino, 2 colori: nero e blu
Taglia unica



09

07

COD. 260018 - KIT 6 FASCE CAPELLI

€ 5,55 kit

Fasce elastiche antiscivolo traspirante
Ideali per calcio, jogging e yoga
Cm 20x1 h

Kit composto da: 2 fasce nere + 2 grigie + 2 bianche



20 - abbigliamento

COD. A17101 - BERMUDA RELAX BLU MICROFIBRA

€ 13,05 cad

Bermuda in poliestere microfibra, 2 tasche laterali, taschino dietro con velcro, ribattiture in contrasto color bianco, da 3XS a 2XL



COD. A17103 - BERMUDA RELAX NERO MICROFIBRA

€ 13,05 cad

Bermuda in poliestere microfibra, 2 tasche laterali, taschino dietro con velcro, ribattiture in contrasto color bianco, da 3XS a 2XL



COD. A16301 - PANTA VOLLEY BLU

€ 8,50 cad

Pantaloncino volley 90% cotone e 10% poliestere
Da 2XS a 2XL



COD. A16303 - PANTA VOLLEY NERO

€ 8,50 cad

Pantaloncino volley 90% cotone e 10% poliestere
Da 2XS a 2XL



COD. 260017 - CALZA GRIP ANTISCIVOLO

€ 3,80 paio

Calza antiscivolo con piede in cotone elasticizzato a pressione differenziata
Con applicazioni in silicone per ridurre lo scivolamento del piede all'interno della scarpa
50% NY, 35% CO, 15% EL
MAN 39/45 (piede cm 23)

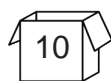

COD. 22CA03 - CALZA AIR

€ 2,96 paio

Calza a doppio risvolto, cavigliera e piede in cotone elasticizzati
 MAN 41/46 (piede cm 26)
 BOY 35/40 (piede cm 23)
 KID 29/34 (piede cm 18)

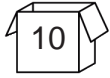

08 02 03 06 07 01 09 04 11 10 05

COD. 205800 - CALZA TUBO

€ 3,96 paio

Calza tubolare a struttura elasticizzata
 Misura unica

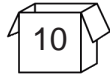

04 07 02 09 01 08 06 05

COD. 001501 - CALZA SHOCK

€ 5,70 paio

Calza a doppio risvolto, cavigliera e piede in cotone elasticizzati, a pressione differenziata, colore fluorescente
 MAN 41/46 (piede cm 26)
 BOY 35/40 (piede cm 23)
 KID 29/34 (piede cm 18)



20 40 60 30

COD. 001305 - CALZA ATHLETIC

€ 3,06 paio

Calza corta multiuso con piede in cotone elasticizzato a pressione differenziata
 Per training, volley e relax
 55% PL, 25% CO, 15% PA, 5% EL
 MAN 41/46 (piede cm 26)
 BOY 35/40 (piede cm 23)

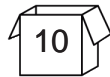

07 01 09



COD. 027022 - NASTRO CALZASU

€ 4,62 cad

Nastro reggicalzettoni e parastinchi adesivo in PVC
 Cm 2x25 mt



22 - palloni

COD. 250705 - PALLONE CALCIO REACTION PRO 5

€ 17,80 cad

Indicato per le gare
Pallone adatto per qualsiasi superficie di gioco e condizione atmosferica
Cucito a macchina
12 pannelli
Gr 410/430
Misura 5
Camera d'aria e valvola in butile
TPU



COD. 250804 - PALLONE CALCIO SOLUTION PRO 4

€ 17,80 cad

Indicato per le gare
Pallone adatto per qualsiasi superficie di gioco e condizione atmosferica
Cucito a macchina
12 pannelli
Gr 360/380
Misura 4
Camera d'aria e valvola in butile
TPU



COD. 250505 - PALLONE CALCIO HURRICANE PRO 5

€ 17,00 cad

Indicato per l'allenamento
 Pallone adatto per qualsiasi superficie di gioco e condizione atmosferica
 Cucito a mano con rifiniture in silicone
 32 pannelli
 Gr 410/430
 Misura 5
 Camera d'aria e valvola in butile
 TPU



Yellow
Giallo



Green
Verde



Red
Rosso



Royal
Blu royal

COD. 250604 - PALLONE CALCIO HELIOS 4

€ 14,00 cad

Indicato per l'allenamento
 Pallone adatto per qualsiasi superficie di gioco e condizione atmosferica
 Cucito a macchina con rifiniture in silicone
 32 pannelli
 Gr 360/380
 Misura 4
 Camera d'aria e valvola in butile
 TPU



Red
Rosso



Green
Verde



Yellow
Giallo



Royal
Blu royal



24 - palloni

COD. 100066 - PALLONE CALCIO GOMMA V41

€ 15,98 cad

Con valvola rigonfiabile
Peso 360 gr
Ø 19,5 cm
Misura 4
Gomma sintetica



MADE
IN
ITALY

COD. 136050 - PALLONE FUTSAL METEOR

€ 32,05 cad

Indicato per l'allenamento e gare indoor e outdoor
Rimbalzo controllato
Gr 400-440
Misura 4
Tpu soft



COD. 100067 - PALLONE CALCIO GOMMA V42

€ 14,96 cad

Con valvola rigonfiabile
Peso 300 gr
Ø 18 cm
Misura 3
Gomma sintetica



MADE
IN
ITALY

COD. 136770 - PALLONE FUTSAL VENUS

€ 29,02 cad

Indicato per l'allenamento outdoor
Rimbalzo controllato
Gr 400-440
Misura 4
Pu



COD. 100074 - PALLONE CALCIO POTENZIATO ULTSE40

€ 48,62 cad

Pallone utilizzato per aumentare il reclutamento delle fibre muscolari, non tossico, senza lattice, misura 5, peso gr 630 (+50%), Ø 21,5



MADE
IN
ITALY

COD. 100073 - PALLONE FUTSAL GOMMA ULT46.2

€ 21,08 cad

Rigonfiabili e indeformabili
Valvola in gomma naturale vulcanizzata
Indicato per l'attività scolastica ufficiale
Rispetta le disposizioni FIGC
Approvati FIGC settore giovanile e scolastico
A rimbalzo controllato entro 60 cm
Non tossico - senza lattice
Gr 380
Ø 20 cm
Misura 4
Gomma doppio strato



MADE
IN
ITALY

COD. 007852 - PALLA CALCIO SPUGNA 20 CM

€ 8,97 cad

Indicato per attività didattica
Ø 20 cm
Misura 3
Spugna



COD. 013066 - PALLONE VOLLEY SCHOOL 5**€ 22,88 cad**

Indicato per scuole
e categorie giovanili
Gr 230-250

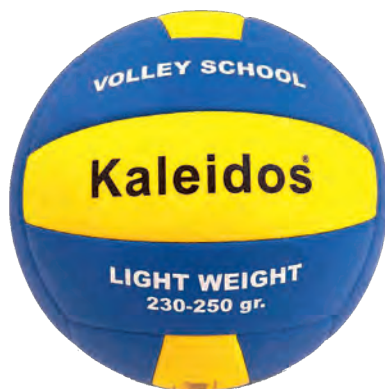
**COD. 136780 - PALLONE BEACH VOLLEY BV1000****€ 25,20 cad**

Utilizzabile su varie superfici
Ideale per allenarsi o giocare a beachvolley sia al chiuso che all'aperto
Approvato FIPAV
Finta pelle soft touch
Con rivestimento impermeabile
Peso 280 gr

**COD. 100084 - PALLONE MINIVOLLEY V33****€ 14,62 cad**

Con valvolina rigonfiabile
Gr 200
ø 20,5 cm
Misura 5
gomma sintetica

**COD. 067320 - PALLONE BEACH SOCCER****€ 24,89 cad**

Appositamente adattato per il gioco sulla sabbia e per resistere all'abrasione.
Diametro: 20 cm
Peso: 380 g
Taglia 5

**COD. 202100 - PALLONE MINIVOLLEY KALEIDOS****€ 6,26 cad**

Ideale per gli allenamenti delle squadre giovanili e dei bambini
PVC soft
Valvola rigonfiabile
Gr 220.

**COD. 100085 - PALLONE SUPERMINIVOLLEY V27****€ 14,62 cad**

Con valvolina rigonfiabile
Gr 250
ø 20,5 cm
Misura 5
gomma sintetica



26 - palloni

COD. 100089 - PALLONE HANDBALL ULT30.3

€ 19,38 cad

Pallone in gomma morbida triplo strato
Ideale per scuole e mini-handball
Misura 2
Femminile



COD. 100095 - PALLONE HANDBALL SOFT BA25

€ 14,62 cad

Con valvola rigonfiabile
Gr 150
Ø 15 cm
Per primo handball
Misura 1
Gomma soft
Junior



COD. 100091 - PALLONE HANDBALL V29

€ 14,28 cad

Con valvola rigonfiabile
Approvati FIGH
Gr 250
Ø 15
Misura 1
Gomma doppio strato
Junior



COD. 100093 - PALLONE HANDBALL SOFT BA0

€ 14,28 cad

Con valvola rigonfiabile
Adatto per principianti
Approvati FIGH
Gr 200
Ø 16 cm
Misura 0
Gomma soft
Junior



COD. 67314C - PALLONE RUGBY 5**€ 17,78 cad**

Pallone ideato per l'introduzione alla pratica del rugby
 Con tasselli per un'ottima presa
 Cucito a mano

**COD. 67314B - PALLONE RUGBY 4****€ 17,78 cad**

Pallone ideato per l'introduzione alla pratica del rugby
 Con tasselli per un'ottima presa
 Cucito a mano

**COD. 67314A - PALLONE RUGBY 3****€ 17,78 cad**

Pallone ideato per l'introduzione alla pratica del rugby
 Con tasselli per un'ottima presa
 Cucito a mano

**COD. 250009 - PALLONE RUGBY U70****€ 25,50 cad**

Pallone propedeutico per il rugby
 In gomma doppio strato anti trauma
 Utilizzabile sia in palestra che all'aperto
 Dimensioni: cm 20/28
 Peso: 450 g

**COD. 223400 - PALLONE MINIRUGBY V71****€ 20,06 cad**

Pallone da minirugby realizzato in gomma monostrato
 Non tossico
 Dimensioni: cm 15/27
 Peso: 350 gr

**COD. 067304 - PALLONE RUGBY SPUGNA****€ 12,54 cad**

Pallone da rugby in schiuma di poliuretano grezzo
 Pallone molto leggero, utilizzato per tutti i tipi di giochi indoor, poiché ha un rimbalzo basso. Ideale per scoprire il rugby indoor
 Ø15 cm
 Peso: 165 g
 Lunghezza 24 cm



28 - palloni

COD. 013733 - PALLONE BASKET KALEIDOS PRO 7

€ 25,61 cad

Pallone ad elevato grip
Indicato per categorie senior e giovanili
Gr 570-650
misura 7
gomma multistrato



COD. 013734 - PALLONE MINIBASKET SB PRO 5

€ 24,00 cad

Pallone ad elevato grip
Indicato per categorie giovanili
Gr 470-500
Misura 5
gomma multistrato



COD. 222000 - PALLA DODGEBALL 2

€ 15,64 cad

Gr 250, ø 20 cm



COD. 213400 - PALLONE SONORO BASKET

€ 111,86 cad

Pallone per basket per non vedenti con 3 campanelli in acciaio, senza rimbalzo
 ø 24 cm
 1,250 kg
 A 2 strati con strato esterno soffice, approvato dal Coni - Federazione Italiana Ciechi
 Colore blu



COD. 222200 - PALLA OFFBALL

€ 17,00 cad

Gr 250, ø 20 cm



COD. 211200 - PALLONE CALCIO SONORO TORBALL

€ 56,10 cad

Pallone per calcio per non vedenti
 Ideale per esercizi di stimolazione percettiva
 3 campanelli in acciaio all'interno
 Gomma monostrato



COD. 258021 - OVERBALL PALLA MORBIDA

€ 14,18 cad

Palla da gioco molto elastica e morbida
 Utilizzabile sia all'aperto che all'interno
 Gonfiabile a fiato
 E' possibile gonfiarla e sgonfiarla al bisogno
 Cannuccia per gonfiaggio inclusa
 ø cm 23



COD. 213500 - PALLONE SONORO HANDBALL 1

€ 49,98 cad

GOALBALL

Pallone per handball per non vedenti ideale per esercizi di stimolazione percettiva con 3 campanelli in acciaio all'interno
 Senza rimbalzo
 ø 15 cm
 0,300 gr
 Gomma sintetica a 2 strati
 Approvato dal Coni - Federazione Italiana Ciechi
 Colore giallo



COD. 014861 - KIT 3 PALLINE TENNIS SPUGNA

€ 2,86 kit

Indicato per attività didattica
 Kit composto da 3 palline
 Ø 7 cm
 Spugna



COD. 230900 - PALLONE SONORO LUI 3

€ 26,98 cad

Pallone multisport con all'interno 2 campanelli che non sbilanciano il rimbalzo, gr 230, ø 24 cm



30 - attrezzatura multisport

COD. 202017 - PALO SLALOM TOP

€ 7,68 cad

Palo slalom in PVC con puntale da utilizzare per terreni naturali
Non abbinabile a nessuna base, altezza 170 cm, ø 32



COD. 032893 - PALO SLALOM ECO H 160

€ 8,84 cad

Palo slalom in PVC con puntale da utilizzare per terreni naturali
Non abbinabile a nessuna base, altezza 160 cm, ø 25

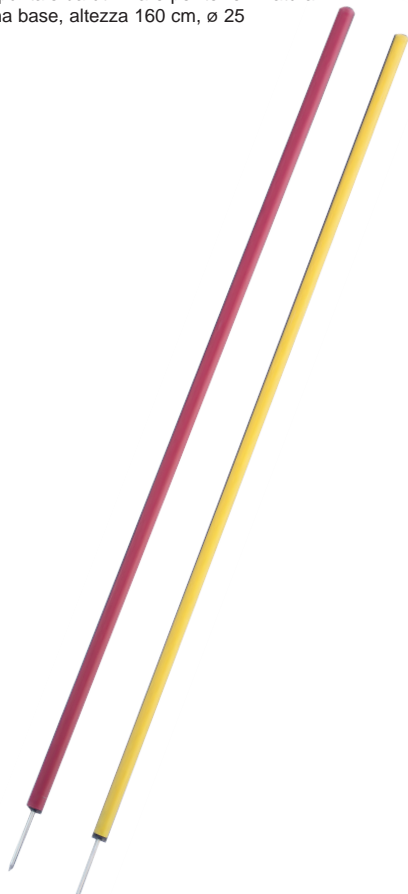

COD. 231602 - ASTA PER BASI CM 160

€ 4,92 cad

Asta in PVC da utilizzare con coni forati e basi
ø 25



COD. 231002 - ASTA CM 100

€ 3,72 cad

Asta in PVC da utilizzare con coni forati e basi
ø 25



COD. 033502 - CLIP GIREVOLE

€ 2,66 cad

Clip girevole in pp da utilizzare per aste e pali con puntale
ø 25



COD. 060001 - BASE PRO

€ 8,80 cad

Base in PVC da utilizzare con aste senza puntale
Peso 1,1 kg
Ø foro 25 mm



COD. 240200 - BASE A CUPOLA MULTIFUNZIONE

€ 14,40 cad

Base a cupola in ABS, riempibile con acqua o sabbia, utilizzabile con aste o cerchi piatti e tondi, le aste possono essere inserite con diverse angolazioni

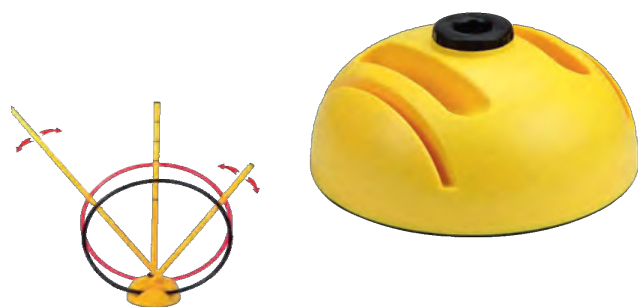

COD. 063346 - BASE A 3 FORI

€ 13,64 cad

Base in PVC con 3 fori da utilizzare per aste senza puntale
Peso 1,3 kg
Ø foro 25 mm



COD. 334020 - BASE CUPOLA ABS

€ 9,96 cad

Base a cupola multifunzione per aste Ø 25 mm, cerchi tondi e piatti
H 11 cm
Ø 20 cm
Peso 350 gr

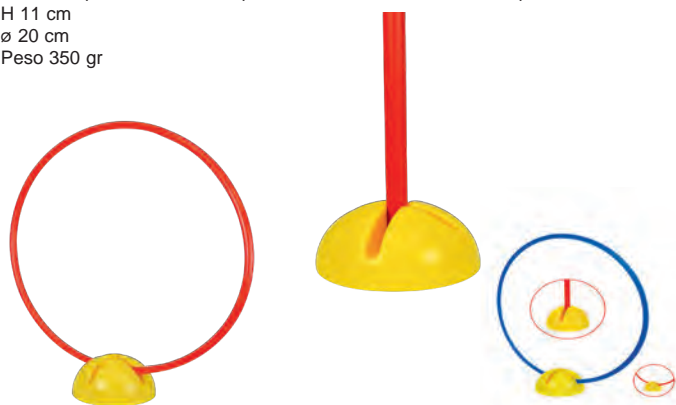

COD. 050040 - KIT 5 CERCHI PIATTI 40

€ 20,40 kit (4,08 € a cerchio)

Cerchio piatto
Ø 40
PVC

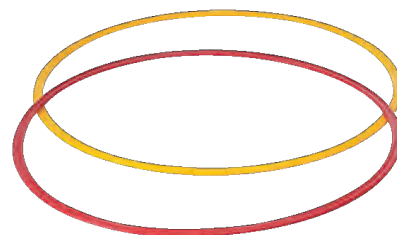

COD. 050050 - KIT 5 CERCHI PIATTI 50

€ 23,20 kit (4,64 € a cerchio)

Cerchio piatto
Ø 50
PVC

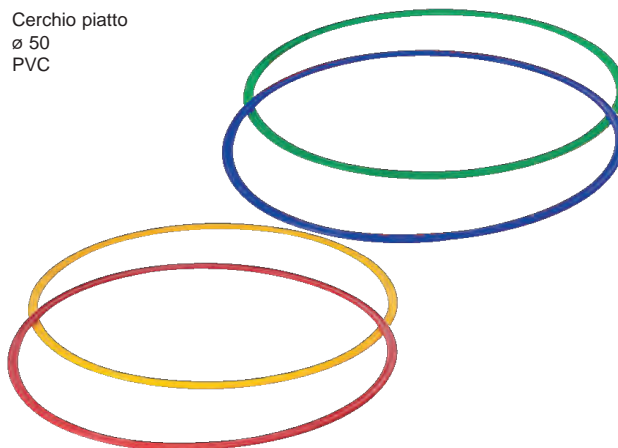

COD. 050060 - KIT 5 CERCHI PIATTI 60

€ 29,80 kit (5,96 € a cerchio)

Cerchio piatto
Ø 60
PVC

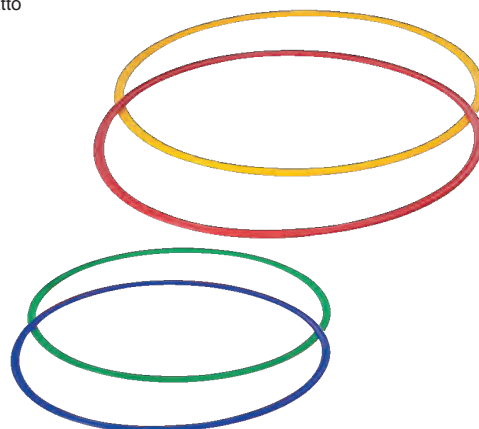

COD. 050070 - KIT 5 CERCHI PIATTI 70

€ 36,30 kit (7,26 € a cerchio)

Cerchio piatto
Ø 70
PVC

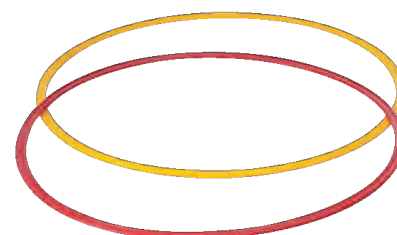

32 - attrezzatura multisport

COD. 205702 - KIT CORNER

€ 80,28 cad

Kit corner composto da 4 pali ø 30 con snodo professionale, 4 boccole da interrare, 4 bandierine e 4 clip

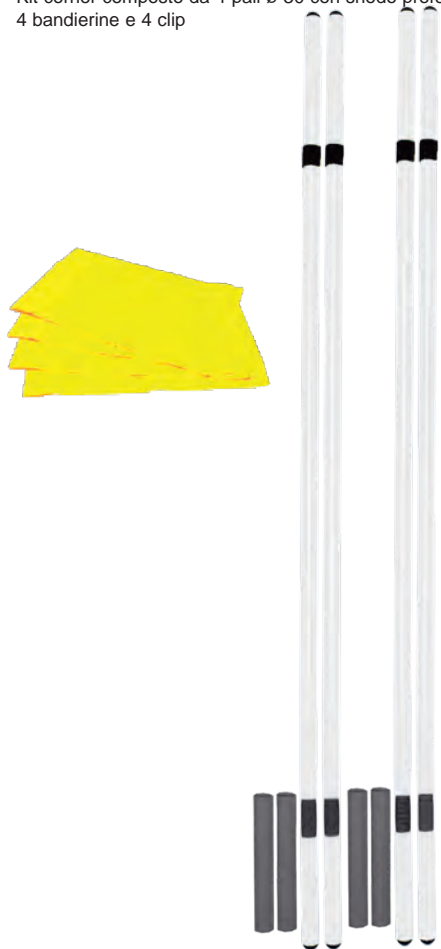

COD. 30052K - KIT CORNER PROFESSIONAL

€ 174,25 cad

Kit corner composto da 4 pali ø 30 con snodo professionale, 4 boccole da interrare, 4 bandierine e 4 clip

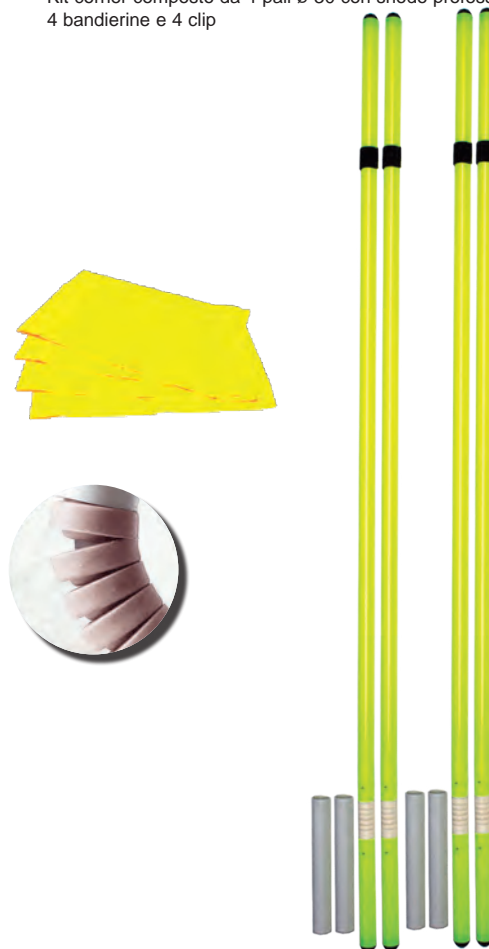

COD. 030011 - KIT 4 BANDIERINE CORNER

€ 13,50 kit

Kit composto da 4 bandierine corner in poliestere
Cm 60x40

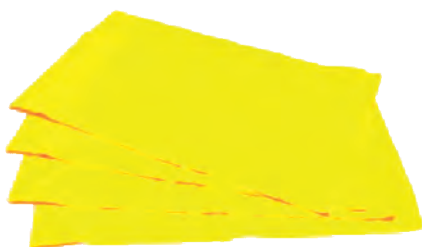

COD. 030151 - BOCCOLA DA INTERRARE

€ 3,50 cad

Boccola in PVC per palo corner
ø 30



COD. 030201 - CLIP FERMABANDIERINA CORNER

€ 1,08 cad

Clip in PVC per palo corner
ø 30



COD. 140007 - SCALA 10 PIOLI REGOLABILI

€ 27,56 cad

Scala in PVC a 10 pioli regolabili alla distanza desiderata, lunghezza metri 4, ad uso professionale



COD. 202306 - SCALA ESAGONALE

€ 30,42 cad

Scala in PVC con esagoni agganciati con clip per permettere la composizione di varie forme per diversi esercizi, metri 3, singolo esagono da 50 cm, sacca inclusa

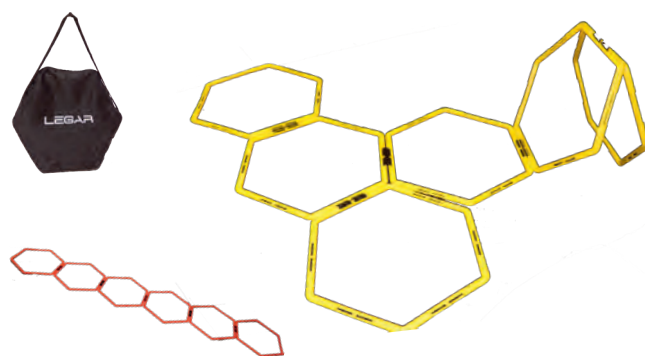

COD. 100531 - SCALA 9 PIOLI

€ 27,32 cad

Scala a 9 pioli, lunghezza metri 4, larghezza cm 55, compresa di picchetti per ancoraggio

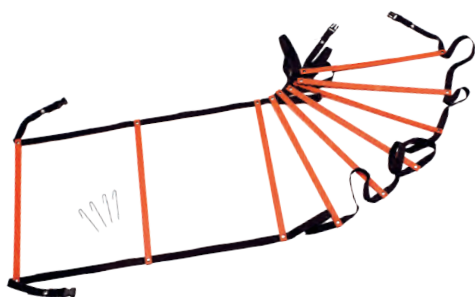

COD. 063456 - SCALA OTTAGONALE

€ 62,39 cad

Scala a 12 ottagononi agganciati tramite clip
 ø 49
 Colore giallo fluo
 Borsa per il trasporto inclusa



COD. 063178 - SCALA DOPPIA 4 PIOLI PIATTI

€ 41,88 cad

Scala a doppia velocità
 Lunghezza 4 metri
 Larghezza 1 metro
 Sacca per il trasporto inclusa

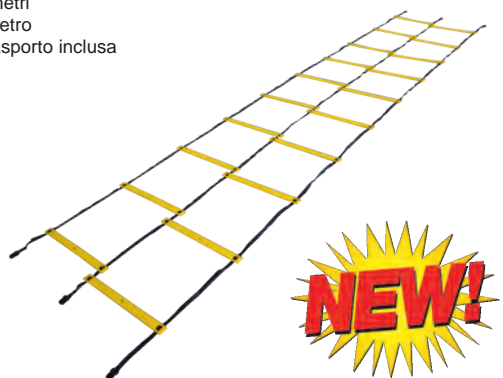

34 - attrezzatura multisport

COD. 233000 - CONO FORATO H 30

€ 5,85 cad

Cono in PE altezza 30 cm, con 12 fori per inserimento aste da \varnothing 25, fessura porta cerchio



COD. 240100 - CONO H 38

€ 4,90 cad

Cono in PE altezza 38 cm, senza fori

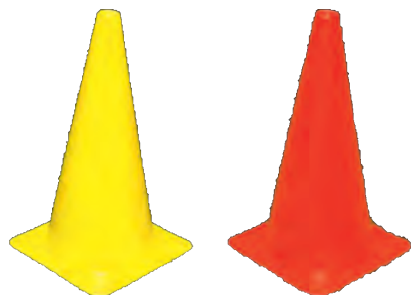

COD. 161118 - CONO FORATO H 50

€ 10,00 cad

Cono in PE altezza 50 cm, con 16 fori per inserimento aste da \varnothing 25, fessura porta cerchio



COD. 032661 - CONO FLUO FORATO H 30

€ 6,67 cad

Cono in PE altezza 30 cm, con 12 fori per inserimento aste da \varnothing 25, fessura porta cerchio



COD. 063013 - CONO CALPESTABILE

€ 4,64 cad

Cono in PVC soft antinfortunistico altezza 15 cm



COD. 100046 - KIT 12 CONI H 30

€ 67,90 kit

Con incavo per asta e sede per cerchio piatto
Pe



COD. 019747 - KIT DELIMITAZIONE CAMPO

€ 22,50 kit

Kit in PVC morbido per delimitare campi da gioco in palestra, composto da 24 pezzi lineari da 39,5 cm, larghezza 4 cm e spessore 2 mm + 4 angoli

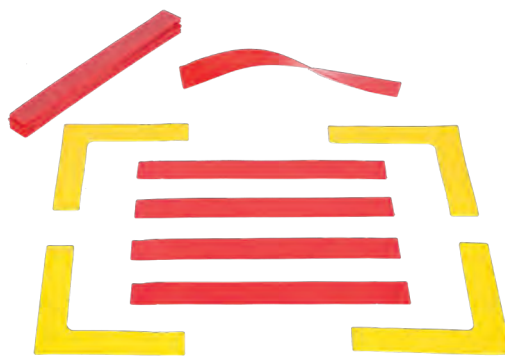

COD. 150005 - KIT 48 DELIMITATORI

€ 27,55 kit

Kit composto da 48 delimitatori colore unico
H 5 cm
PP



COD. 211390 - KIT 24 DISCHI PIATTI

€ 39,00 kit

Kit composto da 24 dischi piatti in gomma flessibile tpr antiscivolo, adatti per l'allenamento dei passaggi e del dribbling senza interferire sulla traiettoria della palla, inclusi di supporto metallico per il trasporto, ø 15 cm
Kit da 12 giallo + 12 arancione oppure kit da 12 bianco + 12 royal



COD. 202300 - KIT 48 DELIMITATORI 4 COLORI

€ 29,00 kit

Kit composto da 48 delimitatori in 4 colori (rosso, bianco, royal, giallo)
H 5 cm
PP



COD. 150481 - KIT 9 DISCHI PIATTI

€ 31,18 kit

Kit composto da 9 dischi piatti in PVC a doppio colore (giallo/rosso o verde/blu)
Per uso interno



COD. 062994 - KIT 12 MAXIDELIMITATORI

€ 44,78 kit

Kit composto da 12 maxi delimitatori (4 rossi + 4 gialli + 4 royal)
Altezza 16 cm
ø 30 cm



COD. 390000 - KIT 10 DISCHI PIATTI NUMERATI

€ 49,30 kit

Kit composto da 10 dischi piatti numerati



36 - attrezzatura multisport

OSTACOLO FLESSIBILE

COD. 106016 - H 12	€ 13,20 cad
COD. 106018 - H 20	€ 14,25 cad
COD. 106019 - H 30	€ 16,20 cad
COD. 106020 - H 40	€ 17,28 cad
COD. 106050 - H 50	€ 20,72 cad
COD. 106060 - H 60	€ 22,83 cad

Ostacolo in pvc a pezzo unico, larghezza cm 75, tubo flessibile ø 25



OSTACOLO BLANCO

COD. 202512 - CM 12	€ 10,73 cad
COD. 202520 - CM 20	€ 11,06 cad
COD. 202530 - CM 30	€ 11,76 cad
COD. 202540 - CM 40	€ 12,95 cad
COD. 202550 - CM 50	€ 13,65 cad
COD. 202560 - CM 60	€ 14,35 cad

Ostacolo in pvc, larghezza cm 70, tubo ø 32



COD. 033800 - OSTACOLO MACH

€ 20,50 cad

Ostacolo in PVC , larghezza cm 80, tubo ø 30, ALTEZZE FISSE DA 10/20/30/40/50/60 CM



 **MADE IN ITALY**

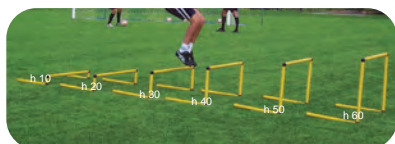

COD. 000205 - OSTACOLO FERRO

€ 30,91 cad

Ostacolo in ferro verniciato, larghezza cm 78, altezze fisse da 12/18/24/30 cm



 **MADE IN ITALY**



COD. 000201 - OSTACOLO FERRO 30/40/50

€ 41,92 cad

Ostacolo in ferro verniciato regolabile in altezza da 30 a 50 cm, larghezza cm 80



COD. 000202 - OSTACOLO REGOLABILE FERRO

€ 49,37 cad 60/70/80/90

Ostacolo in ferro verniciato regolabile in altezza da 60 a 90 cm, larghezza cm 100



COD. 033850 - OSTACOLO REGOLABILE MACH 2

€ 30,77 cad

Ostacolo in pvc regolabile in altezza da cm 10 a 60, larghezza cm 80, tubo ø 30

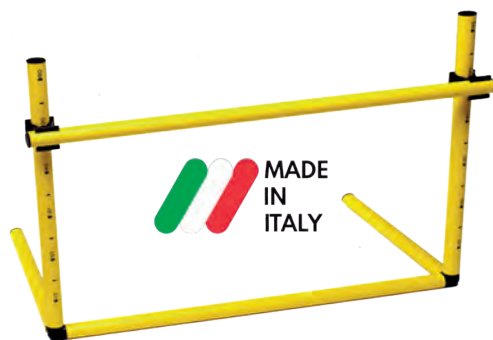

COD. 025032 - OSTACOLO REGOLABILE KID

€ 14,21 cad

Ostacolo in pvc regolabile in 3 diverse altezze da 15/23/29 cm, larghezza cm 46

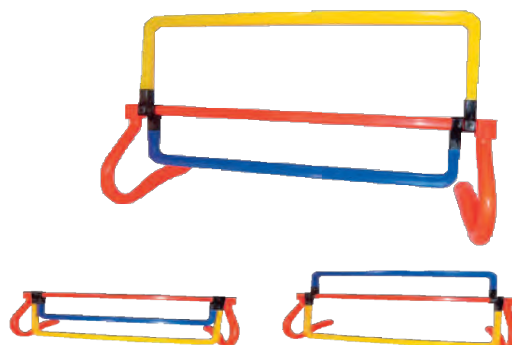

OSTACOLO BASCULANTE

COD. 63302B - CM 26

€ 25,31 cad

COD. 63302D - CM 36

€ 28,39 cad

COD. 63302E - CM 50

€ 33,59 cad

Ostacolo a pezzo unico che si rialza rapidamente in maniera autonoma, larghezza cm 70,



38 - attrezzatura multisport

COD. 063476 - SAGOMA GONFIABILE H 180

€ 102,00 cad

Sagoma gonfiabile in PVC utilizzabile per l'allenamento di portieri e calciatori, torna sempre nella posizione verticale iniziale, base riempibile con acqua o sabbia, parte superiore gonfiabile con una pompa, maniglie laterali per il trasporto, resistente all'acqua e anti-UV, kit di riparazione incluso



COD. 063477 - SAGOMA GONFIABILE H 205

€ 120,00 cad

Sagoma gonfiabile in PVC utilizzabile per l'allenamento di portieri e calciatori, torna sempre nella posizione verticale iniziale, base riempibile con acqua o sabbia, parte superiore gonfiabile con una pompa, maniglie laterali per il trasporto, resistente all'acqua e anti-UV, kit di riparazione incluso



COD. TA1600 - SAGOMA SOCCER WALL

€ 38,00 cad

Sagoma con maglia in rete ideale per le simulazioni da gioco, utilizzabile con qualsiasi tipo di asta o palo

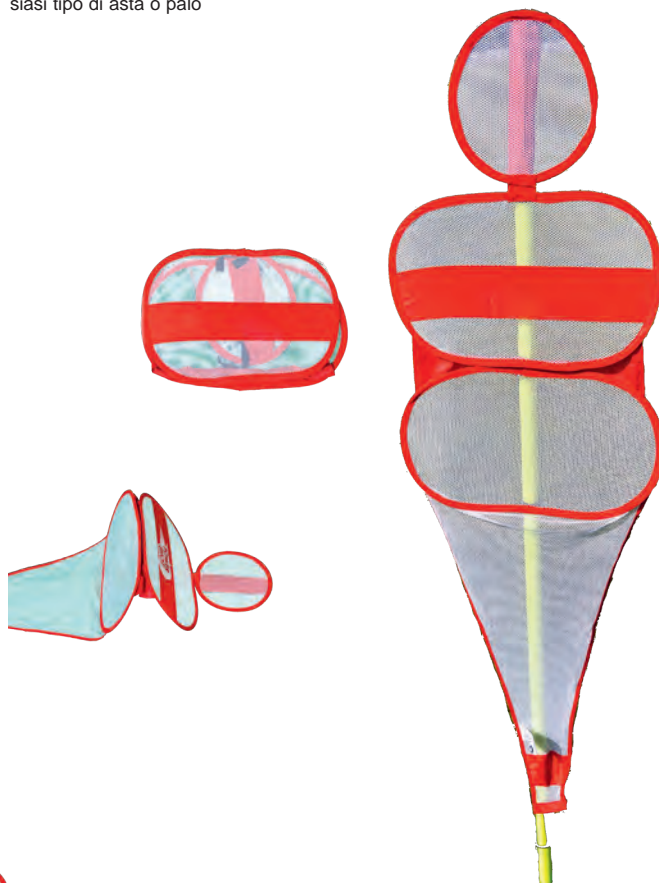

COD. 063471 - KIT 3 SAGOME SNODATE

€ 376,48 kit

Kit composto da 3 sagome snodate ideali per l'allenamento e il perfezionamento dei calci di punizione, larghezza 50 cm, altezza 180 cm, sagoma in plastica e puntale in acciaio



COD. 062715 - CARRELLO PER SAGOME

€ 238,11 cad

Carrello in ferro verniciato per il trasporto di sagome con puntale, incluse ruote per il trasporto, ideale sia per terreni sintetici che naturali
Sagome non incluse
Compatibile con sagome 063471 e 202118

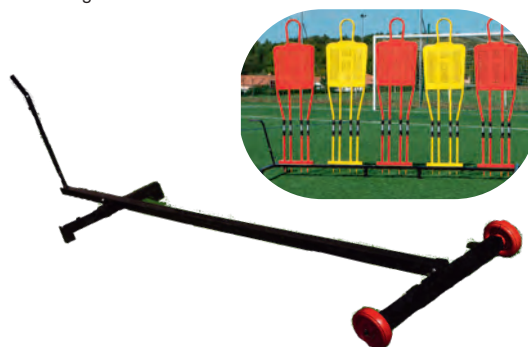

COD. 063454 - BASE PER SAGOMA

€ 78,03 cad

Base per sagome con puntale, ideale sia per terreni sintetici che naturali, kg 12



COD. 202118 - SAGOMA PRO FKM

€ 129,40 cad

Sagoma in PVC, flessibile, altezza cm 180



COD. 063344 - BASE PER PORTA E SAGOMA

€ 85,14 cad

Base 2 in 1 per porte e sagome con puntale
Gli artigli da un lato permettono di agganciare la base alla porticina per impedirne il ribaltamento
Compatibile con le porticine con tubo da ø 40
Maniglie laterali per facilitare il trasporto
Peso 12 kg
Dimensioni: 50x32x11,2 h

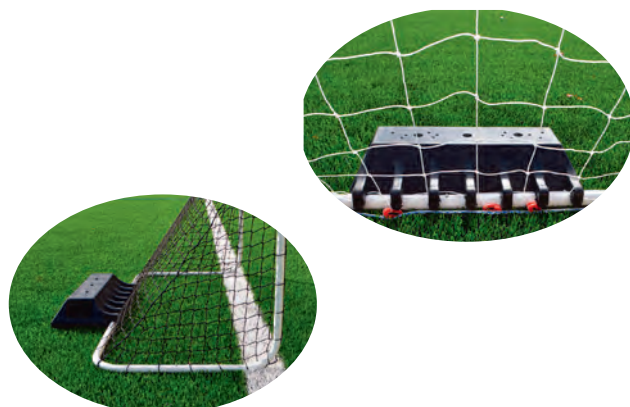

40 - attrezzatura multisport

COD. FA0600 - ELASTICO ALLENAMENTO PORTIERI

€ 122,40 cad

Questo articolo è perfetto per l'allenamento dei portieri calcio
L'elastico si lega intorno al portiere e ai pali della porta



COD. 326930 - MATERASSO PORTIERI

€ 671,50 cad

Materassino pieghevole per allenamento portiere in materiale morbido
Densità 30
Per terreni duri
Con velcro antiscivolo
Misure cm 200x390x6 h



COD. 200200 - MATERASSO H 10

€ 361,15 cad

Per allenamento portieri
cm 200x100x10
Gomma piuma/pvc

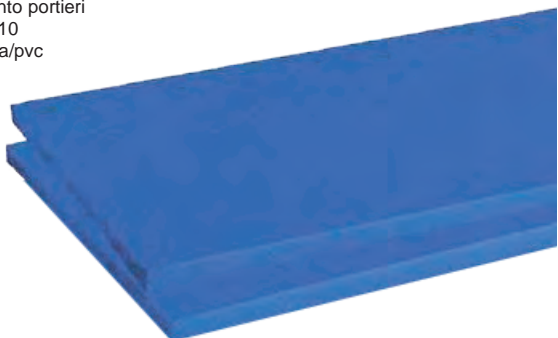

COD. 203400 - FODERA MATERASSO

€ 223,20 cad

Per fodere antiscivolo prezzo a preventivo
Antibatterico, antimuffa, ignifugo cl.2

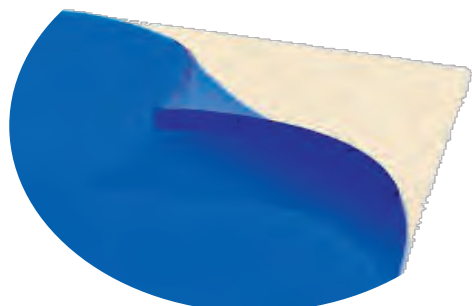

COD. 080203 - TRALICCIO GIOCO TESTA

€ 334,90 cad

Per allenamento gioco calcio
Altezza da terra mt 3
Apertura totale mt 3
Smontabile
Compreso di bossola da interrare
Esclusi corda e pallone

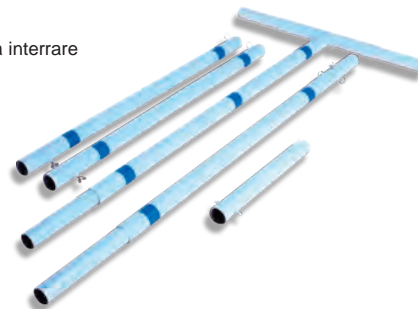

COD. 211400 - PALLONE FORCA GOMMA MIS 5

€ 39,44 cad

Pallone in gomma doppio strato
Gr 420
ø 21,5 cm

MADE
IN
ITALY



COD. 060203 - CORDE PER TRALICCIO

€ 13,19 paio



COD. 064226 - TELAIO 100x100 INCLINABILE

€ 202,30 cad

Telaio con inclinazione regolabile
Cm 100x100
Kg 6,6



COD. 307050 - TELAIO PORTIERE 60x60

€ 56,92 cad

Telaio con maniglie in acciaio 60x60 cm
Rete maglia 4x4 cm
Peso 2 kg
Ferro verniciato



COD. 064106 - KIT 4 BERSAGLI PER TIRI DI PRECISIONE

€ 118,98 kit

Kit di 4 bersagli in poliestere resistente
Con velcro
Ideale per allenare il tiro
Viene fornito con la sua borsa per il trasporto

Dimensioni bersaglio: 60x60 cm

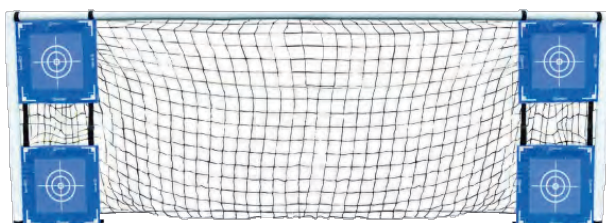

COD. 64123R - TELAIO TCHOUKBALL

€ 211,58 cad

Telaio in metallo cm 100x100, peso 8 kg

COD. 64123F - RETE RICAMBIO TELAIO TCHOUKBALL

€ 71,33 cad

Rete misura 100x100 compatibile con il telaio 64123R



42 - attrezzatura multisport

COD. 200270 - LAVASCARPE GREEN

€ 301,34 cad

Supporto poggiamani smontabile, 2 spazzole inferiori e 2 spazzole laterali, 4 getti d'acqua incrociati con angolazione regolabile, in acciaio verniciato

 **MADE
IN
ITALY**

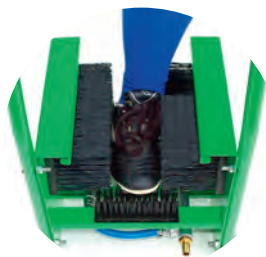

COD. 202701 - KIT SPAZZOLE BASE

€ 31,96 kit

Kit 2 spazzole per base lavascarpe green, cm 15x5, NY



COD. 202702 - KIT SPAZZOLE LATERALI

€ 76,84 kit

Kit 2 spazzole laterali per lavascarpe green, cm 25x10, NY

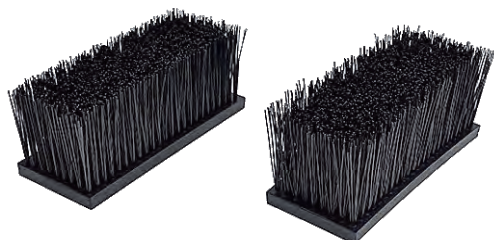

COD. 099046 - IMPIANTO CALCIO TENNIS MT 4

€ 180,92 cad

Struttura rettangolare in acciaio molto stabile grazie alla larghezza dei piedi che evita qualsiasi rischio di ribaltamento
Progettato per l'uso su qualsiasi tipo di superficie
Facile da installare
Fornito con borsa per il trasporto
Altezza regolabile da m 0,90 a m 1,10
Lunghezza m 4
Inclusa rete in pe da mm 2, maglia mm 40



COD. 099048 - IMPIANTO CALCIO TENNIS 300x80

€ 91,88 cad

Impianto calcio/tennis con struttura in tubo d'acciaio da \varnothing 19
Facile da montare e smontare
Borsa per trasporto inclusa
Mt 3x0,8 h



COD. 032701 - ARCO DI PRECISIONE

€ 28,05 cad

Tubo flessibile regolabile
in altezza e larghezza
Punta in acciaio
cm 30/80
Pvc



COD. 1AT010 - KIT SPAZZOLE MUD CLEANER

€ 79,52 kit

Ricambio spazzole: 2 laterali + 1 base
Spazzola base cm 28x11,5x6 h
Spazzola laterale cm 31,5x7,5x11 h



COD. 064126 - PANNELLO RIMBALZANTE PIEGHEVOLE

€ 222,22 cad

Pannello ideale per allenare e perfezionare la tecnica
Facilita gli esercizi di passaggio a terra
Garantisce un'eccellente stabilità grazie ai rinforzi laterali
Si ripiega facilmente ed è facile da trasportare grazie alla maniglia
Può essere utilizzato in 2 posizioni (orizzontale o inclinato per il volley)
Dimensioni: cm 100x40x40
Peso 11,8 kg



COD. 060063 - SLITTA POWER SPEED

€ 104,20 cad

Slitta da traino in ferro verniciato
Pesi esclusi
Cintura regolabile
Peso 3,5 kg
Peso massimo caricabile 60 kg
Larghezza 37 cm
Lunghezza 55 cm



COD. 032055 - SLITTA DA TRAINO

€ 181,30 cad

Slitta da traino in ferro verniciato, pesi esclusi
Peso 6 kg
Larghezza 40 cm
Lunghezza 50 cm



COD. 031212 - TRAMPOLINO ELASTICO

€ 110,70 cad

6 piedini in metallo con gomma antiscivolo, superficie di salto 77 cm, peso massimo 100 kg, altezza 22,5 cm, ø 100 cm



COD. 100800 - SACCA DA TRAINO

€ 154,55 cad

Sacca da traino sprintsac riempibile con sabbia fino a 20 kg



COD. 031501 - NASTRO DELIMITAZIONE PERCORSI

€ 10,71 cad

Per delimitare i percorsi
mt 200
Pe

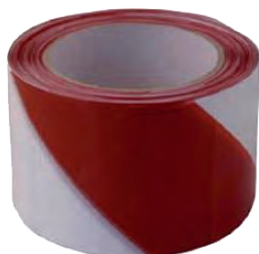

COD. 223000 - SLITTA CROSS TRAINING

€ 406,98 cad

Slitta per cross training dotata di 3 pattini antiscivolo e barre di spinta con incastro a baionetta, piano di carico con un'asta di inserimento dischi del foro Ø 50 mm e un montante ad albero con perni per dischi del foro di Ø 25 mm
Incluso giubbino in nylon con cinghie imbottite per esercizi di trazione
Ideale per terreni sintetici
Peso massimo caricabile 270 kg



44 - attrezzatura multisport

COD. 00403G - CONTENITORE CHIUSO GRANDE

€ 468,96 cad

Contentore in ferro verniciato, completo di lucchetto, capienza 34/36 palloni, adatto per la raccolta di accessori allenamento (ostacoli, cerchi, coni, etc), ruote incluse, cm 100x75x90 h



 **MADE IN ITALY**

COD. 000405 - CONTENITORE CHIUSO MEDIO

€ 383,66 cad

Contentore in ferro verniciato, completo di lucchetto, contiene 24/26 palloni, ruote incluse, cm 75x70x90 h



 **MADE IN ITALY**

COD. 119002 - CONTENITORE CHIUSO PIEGHEVOLE

€ 193,80 cad

Contentore in ferro zincato, contiene 16/18 palloni, consigliato per le piscine, ruote incluse, cm 80x50x70 h



 **MADE IN ITALY**

COD. 21403Z - CONTENITORE CHIUSO ZINCATO

€ 514,45 cad

Contentore in acciaio zincato tropicalizzato, completo di lucchetto, contiene 35/40 palloni, consigliato per le piscine, ruote comprese, cm 100x75x90 h



 **MADE IN ITALY**

COD. 000402 - CONTENITORE APERTO ZINCATO

€ 205,53 cad

Contentore in ferro zincato con sacca in nylon pesante, pieghevole, sfoderabile, cm 60x60x90 h

 **MADE IN ITALY**



COD. 900800 - CONTENITORE APERTO ALLUMINIO

€ 99,60 cad

Contiene 18/20 palloni
Cm 102x42x27

NEW!



COD. 200406 - CONTENITORE PORTA ATTREZZI

€ 1.686,06 cad

Contentore in acciaio zincato, ripiani regolabili in altezza, ruote girevoli di cui 2 con freno, completo di lucchetto, cm 156x76x163 h



 **MADE IN ITALY**



 **MADE IN ITALY**



COD. 411600 - MINICOMPRESSORE RAIDER

€ 182,90 cad

Compressore a cilindro posteriore
Pressione massima 200 PSI
Pressione media 150 PSI
3 diversi tipi di ago
Inclusa borsa per il trasporto
Peso 2,1 kg
Misure: 24x17x14



COD. 062982 - BLISTER 3 AGHI PER MANOMETRO

€ 4,60 blister

Per il compressore serve l'ugello



COD. 063076 - POMPA A STAFFA CON MANOMETRO

€ 28,05 cad

Pompa a staffa con manometro
Ago per gonfiaggio incluso
Pvc



COD. 062993 - KIT 12 AGHI PER MANOMETRO

€ 9,78 kit

Per il compressore serve l'ugello



COD. 063269 - POMPA A MANO PRO

€ 7,50 cad

Slitta da traino in ferro verniciato, pesi esclusi



COD. 063012 - UGHELLO PER ADATTARE AGO

€ 3,56 cad

Ugello per adattare l'ago a compressori, pompe e manometro 190600

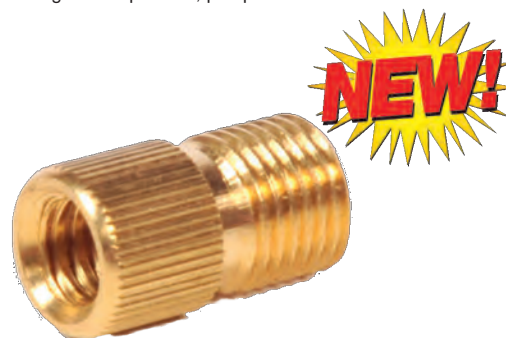

COD. 009993 - MANOMETRO PRO

€ 15,30 cad



COD. 190600 - MANOMETRO

€ 7,80 cad



46 - attrezzatura multisport

COD. 122001 - BIRRACCIA

€ 3,20 cad

Capienza 1 litro, tappo a ciucio, PE



COD. 062782 - BIRRACCIA IGIENICA

€ 5,85 cad

Capienza 800 ml

Tappo specifico per sottogola per bere senza contatto



COD. 340000 - CESTELLO PIEGHEVOLE

€ 13,60 cad

6 posti, totalmente pieghevole, facile da aprire e chiudere, cm 29x21x27 h, PP



COD. 422130 - CESTELLO PORTABORRACCE

€ 7,92 cad

6 posti, pratica impugnatura per trasporto, cm 30x21x28 h, PP



BORRACCE PRAXI

COD. 999300 - 800 ML/CARTONE DA 50 PZ € 3,37 cad

COD. 999100 - 600 ML/CARTONE DA 70 PZ € 3,20 cad



24

87

704

18

27

17

707

28



14

**BORRACCE NEI COLORI SOCIALI SENZA STAMPA
CONSEGNA 20 GIORNI
VENDUTE A CARTONE COMPLETO**



47



BORRACCE PERSONALIZZATE

COD. 122010 - 1 COLORE/300 PZ € 5,81 cad
COD. 122006 - 1 COLORE/600 PZ € 4,45 cad
COD. 122004 - 1 COLORE/1200 PZ € 4,08 cad

COD. 122011 - 2 COLORI/300 PZ € 6,70 cad
COD. 122007 - 2 COLORI/600 PZ € 5,07 cad
COD. 122005 - 2 COLORI/1200 PZ € 4,56 cad

COD. 122003 - IMPIANTO STAMPA € 266,00 a singolo colore



PER BORRACCE PERSONALIZZATE DA 1 LITRO

COLORE CORPO: BIANCO O GIALLO
 COLORE TAPPO: NERO, GIALLO, ROSSO E ROYAL

CONSEGNA 45 GIORNI



48 - arbitro

COD. 024017 - CRONOMETRO SCOLASTICO

€ 10,89 cad

Cronometro scolastico 1 tempo + parziale, altezza dei numeri 12 mm, precisione 1/100 secondi, tempo di cronometraggio 24 h, 6 cifre, batterie LR44, consegnato in blister



COD. 024002 - CRONOMETRO 30 MEMORIE

€ 39,56 cad

Cronometro a 30 memorie, altezza numeri 8/6 mm, precisione tempo 1/100 secondi, tempo di cronometraggio 10 h, funzione conto alla rovescia programmabile e con segnale di scadenza, contatore di sequenza, tempo intermedio LAP e SPLIT, resistente agli spruzzi d'acqua, Batteria CR2032



COD. 150006 - KIT ARBITRO FOX

€ 62,00 kit

Kit professionale composto da: cronometro/orologio da polso resistente all'acqua e agli urti, fischiello Sonic Blast CMG, cordoncino antipanico,



COD. 024104 - CRONOMETRO 50 MEMORIE

€ 55,44 cad

Memorizzazione 50 tempi intermedi + tempo cumulativo, altezza numeri 7,5/5 mm, tempo di cronometraggio 10 h, funzione conto alla rovescia, resistente agli spruzzi d'acqua, batteria CR2032, consegnato con blister



COD. 063369 - FISCHIO ELETTRONICO FOX

€ 41,40 cad

Fischiello elettronico FOX a comando manuale, garantisce l'igiene, il suono può essere diretto nella direzione desiderata, 3 diversi toni, batteria inclusa
Possibile azionarlo tramite tasto
Massimo 100 DB



COD. 063485 - FISCHIO ELETTRONICO DIGI

€ 26,83 cad

Fischiello elettronico con controllo manuale
2 diversi toni
Massimo 110 DB
Laccio incluso
Batterie non incluse



NEW!

COD. 250004 - FISCHIO FOX 40 CLASSIC

€ 8,50 cad

Fischio professionale senza pallina
PVC



COD. 250005 - FISCHIO FOX 40 CMG

€ 11,90 cad

Fischio professionale senza pallina, con punta anatomica in gomma, PVC



COD. 205600 - KIT FISCHIO STRIDER

€ 14,40 kit

Kit composto da 12 fischietti a colore unico
PVC



COD. 000371 - FISCHIO METALLO + CORDONCINO

€ 2,70 blister

Fischio in metallo color oro, cordoncino incluso



COD. 205400 - KIT FISCHIO METALLO

€ 12,00 kit

Kit composto da 12 fischietti



COD. 401200 - KIT 12 CORDONCINI DA POLSO

€ 10,20 kit

Kit composto da 12 cordoncini da polso in nylon
Cm 25



COD. 240080 - CORDONCINO FISCHIO

€ 1,53 cad

Cordino in nylon per fischietto



COD. 250003 - CORDONCINO ANTIPANICO

€ 3,23 cad

Cordoncino fischio dotato di meccanismo antipanico, si sgancia solo se rimane impigliato



50 - arbitro

COD. 220300 - KIT CARTELLINI RISCRIVIBILI CALCIO

€ 11,22 kit

Kit composto da 1 cartellino rosso, 1 cartellino giallo e 1 pennarello



COD. 063095 - KIT GUARDALINEE

€ 18,66 kit

Kit composto da 2 aste con manopola, 2 bandierine a scacchi, 1 busta e 2 clip



COD. 250002 - CARTONCINO ARBITRO PARTITA

€ 0,51 cad

Venduto a confezione da 10 cartoncini



AMM. N.	ESP.	MOTIVAZIONE	CALCIO D'INIZIO	ora d'Inizio 1° tempo	AMM. N.	ESP.	MOTIVAZIONE
1			(Sostituito)	ora d'Inizio 2° tempo	1		
2			LOCALI (O) MAGLIA		2		
3			OSPITI (O) MAGLIA		3		
4			CAP. VICE		4		
5			Reti 1° Tempo		5		
6					6		
7			Reti 2° Tempo		7		
8					8		
9			Reti 2° Tempo		9		
10					10		
11			Sostituzioni		11		
12					12		
13					13		
14					14		
15					15		
16					16		
17			SPRESENTI		17		
18					18		

COD. 030801 - BANDIERINA SCACCHI GUARDALINEE

€ 7,41 cad

Bandierina in PI, cm 40x40



COD. 310050 - CUSTODIA + CARTELLINI ARBITRO

€ 8,67 cad



COD. 030851 - BANDIERINA GIALLA GUARDALINEE

€ 5,95 cad

Bandierina in PI, cm 40x40



COD. 030202 - CLIP FERMABANDIERINA GUARDALINEE

€ 0,68 cad

Clip in PE, ø 20 mm



COD. 063214 - KIT GUARDALINEE ELETTRONICO

€ 1.123,56 kit

- Kit bandierine elettroniche composto da:
 2 bandierine
 1 ricevitore per l'arbitro centrale
 1 custodia per il ricevitore
 1 cavo di ricarica a 3 connettori
 1 adattatore USB
 1 borsa rigida per trasporto
 1 libretto di istruzioni



Trasmissione a lungo raggio, durata batteria da 20 ore
 Regolazione del volume e della vibrazione su 5 livelli tramite ricevitore
 Tasto OFF e stand-by automatico



COD. 954500 - FASCIA CAPITANO MAN

€ 3,42 cad

Fascia capitano elasticizzata 80% poliestere e 20% elasthan
 Con elastico per facilitare il posizionamento sul braccio
 Velcro per la chiusura
 Misura: 35x8,5 cm

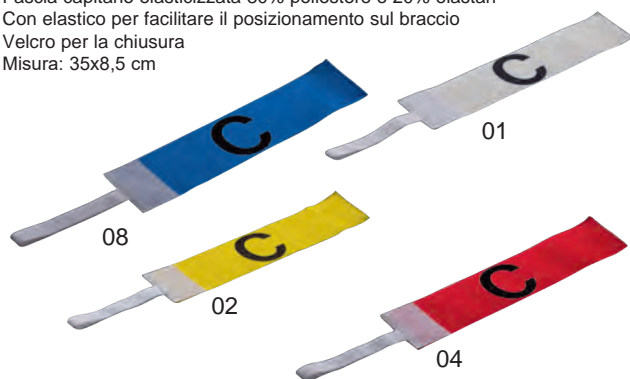

COD. 954600 - FASCIA CAPITANO BOY

€ 3,42 cad

Fascia capitano elasticizzata 80% poliestere e 20% elasthan
 Con elastico per facilitare il posizionamento sul braccio
 Velcro per la chiusura
 Misura: 31x8 cm

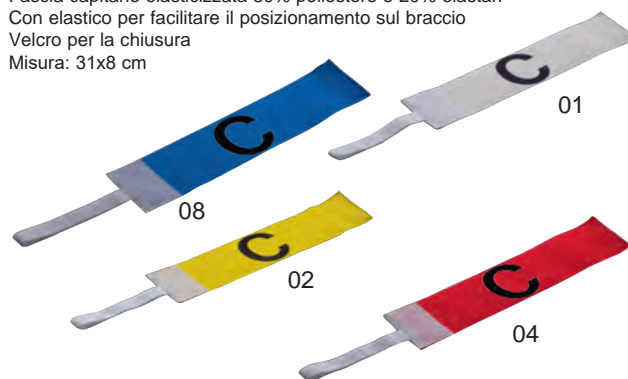

COD. 063266 - FASCIA CAPITANO MAXI

€ 5,05 cad

Fascia capitano elasticizzata 80% poliestere e 20% elasthan, con velcro per la chiusura, con elastico per facilitare il posizionamento sul braccio, ideale per applicazioni di stampe e scudetti
 Misura unica cm 33x9 h

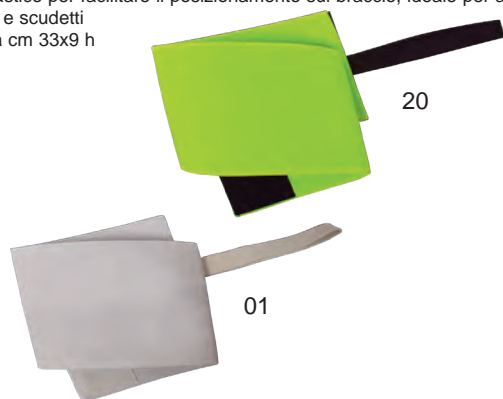

COD. 063257 - FASCIA LUTTO

€ 4,19 cad

Fascia lutto elasticizzata
 Misura unica h 5



52 - arbitro

COD. 29202S - TABELLA ELETTRONICA CAMBIO

€ 1.127,63 cad **GIOCATORI 2 LATI**

Tabellone elettronico per la sostituzione giocatori del calcio e rugby
Visualizzazione su 2 lati
Altezza cifre 23,5 cm
Distanza di leggibilità 100 mt
Led rossi per il giocatore in uscita, led verde per il giocatore in entrata
Per uso esterno, resistente all'acqua
Con tastiera a membrana
Batteria interna a litio, riciclabile e con visualizzatore di livello carica
Fino a 6 memorizzazioni delle sostituzioni giocatore
Funzione di auto-spegnimento
Caricabatteria in dotazione
Spazio riservato per adesivo sponsor
Conforme alle norme EN62368-1
Kg 2,25
58,2x38,3x2,7



COD. 068001 - TABELLA ELETTRONICA CAMBIO

€ 560,83 cad **GIOCATORI**

Tabellone elettronico per la sostituzione giocatori, segnala i giocatori entranti ed uscenti da 0 a 99, è possibile segnalare il tempo aggiuntivo da 0 a 9 min, visibilità fino a 120 m, dimensione numeri 18x10 cm, batteria al litio con caricabatterie
Durata della batteria 5 ore di utilizzo, cm 55x26, kg 2



COD. 29201S - TABELLA ELETTRONICA CAMBIO

€ 790,50 cad **GIOCATORI 1 LATO**

Tabellone elettronico per la sostituzione giocatori del calcio e rugby
Visualizzazione su 1 lato
Altezza cifre 23,5 cm
Distanza di leggibilità 100 mt
Led rossi per il giocatore in uscita, led verde per il giocatore in entrata
Per uso esterno, resistente all'acqua
Con tastiera a membrana
Batteria interna a litio, riciclabile e con visualizzatore di livello carica
Fino a 6 memorizzazioni delle sostituzioni giocatore
Funzione di auto-spegnimento
Caricabatteria in dotazione
Spazio riservato per adesivo sponsor
Conforme alle norme EN62368-1
Kg 2,2
58,2x38,3x2,7



COD. 031051 - BLOCCO CAMBIO GIOCATORI 1/30**€ 30,94 cad**

Blocco giocatori senza manico, numeri da 1 a 30, cm 34x24 h

**COD. 062797 - TABELLA CON MANIGLIE CAMBIO****€ 58,55 cad****GIOCATORI**

Bifacciale, numeri da 1 a 99, un lato con numeri gialli e un lato con numeri arancione, cm 58x30, PVC

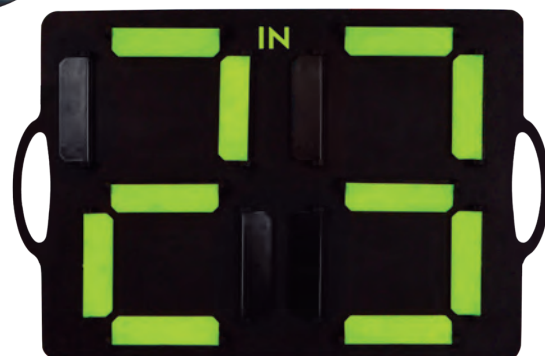
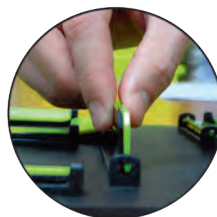
**COD. 231500 - BLOCCO CAMBIO GIOCATORI 1/25****€ 25,00 cad**

Blocco giocatori senza manico, numeri da 1 a 25, cm 34x24 h

**COD. 031041 - TABELLA HANDY CAMBIO GIOCATORI****€ 82,45 cad**

Tabella in PVC bifacciale (un lato giallo e un lato arancione), numeri da 1 a 99, cm 41x34 h



54 - lavagne

COD. 063037 - LAVAGNA LCD CALCIO

€ 56,10 cad

Lavagna a due lati: un lato LCD con cancellazione istantanea dello schermo tramite un tasto, un lato scrivibile con pennarello cancellabile
Pennino magnetico e pennarello inclusi
Per caricarla utilizzare un caricabatterie DC 5V non incluso oppure un cavo USB-C incluso
Dimensioni: 33,5x23,5 cm



COD. HA0020 - LAVAGNA HANDBALL PICCOLA

€ 13,60 cad

Senza pedine
Cancellabile
cm 23x34
Pennarello incluso

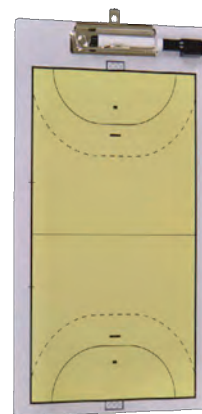

COD. 063192 - LAVAGNA BADMINTON PICKLEBALL

€ 17,71 cad

Lavagna rigida cancellabile con clip in metallo
Un lato raffigura il campo da badminton, l'altro lato un campo da pickleball
Pennarello incluso
Dimensioni: 22,5x36 cm
Pvc



COD. 063045 - BORSA PER LAVAGNA LCD

€ 15,73 cad

Borsa per il trasporto di lavagne LCD
Poly 420D
Dimensioni: 27x36 cm



COD. 063191 - LAVAGNA PADEL TENNIS

€ 17,71 cad

Lavagna rigida cancellabile con clip in metallo
Un lato raffigura il campo da padel, l'altro lato un campo da tennis
Pennarello incluso
Dimensioni: 22,5x36 cm
Pvc



COD. 063019 - PENNA PER LAVAGNA LCD

€ 3,56 cad

Pennino magnetico per lavagne LCD



COD. FA0060 - LAVAGNA CALCIO GRANDE MAGNETICA**€ 105,03 cad**

Magnetica
 Pedine comprese
 Pennarello incluso
 cm 90x60

**COD. BBA050 - LAVAGNA BASKET GRANDE MAGNETICA****€ 111,15 cad**

Lavagna basket ideale per l'organizzazione del piano tattico prima della partita
 cm 90x60
 materiale plastico
 Pedine comprese
 Pennarello incluso

**COD. FA0070 - LAVAGNA CALCIO MEDIA MAGNETICA****€ 85,50 cad**

Magnetica
 Pedine comprese
 Pennarello incluso
 cm 60x45

**COD. HA0010 - LAVAGNA HANDBALL GRANDE MAGNETICA****€ 76,95 cad**

Lavagna handball magnetica e cancellabile
 Ideale per stabilire la strategia di gioco prima della partita
 cm 90x60
 Pedine comprese
 Pennarello incluso



56 - lavagne

COD. 063200 - LAVAGNA CALCIO 3D

€ 17,71 cad

Lavagna rigida in PVC cancellabile con clip metallica
Un lato a tutto campo e un lato a metà campo
22,5 cm x 36 cm
Pennarello incluso



COD. 063420 - LAVAGNA VOLLEY 3D

€ 17,71 cad

Lavagna cancellabile in PVC rigido con clip in metallo
Un lato a tutto campo e un lato a metà campo
Dimensione: 36x22,5 cm.
Pennarello incluso

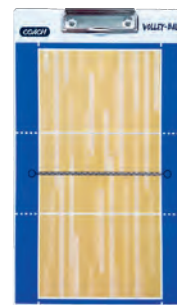

COD. 063201 - LAVAGNA HANDBALL 3D

€ 17,71 cad

Lavagna cancellabile in PVC rigido con clip in metallo
Un lato a tutto campo e un lato a metà campo
Dimensione: 22,5 x 36 cm
Pennarello cancellabile incluso

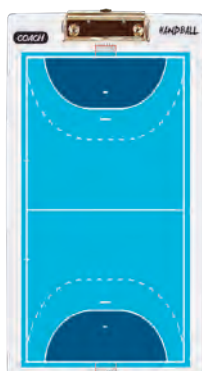

COD. 063203 - LAVAGNA RUGBY 3D

€ 17,71 cad

Lavagna cancellabile in PVC rigido con clip in metallo
Un lato a tutto campo e un lato a metà campo
Viene fornito con un pennarello
Larghezza: 22,5 cm
Lunghezza: 36 cm

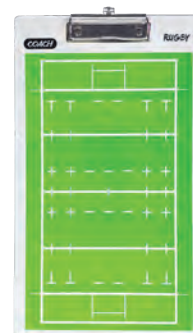

COD. 063202 - LAVAGNA BASKET 3D

€ 17,71 cad

Lavagna cancellabile in PVC rigido con clip in metallo
Un lato a tutto campo e un lato a metà campo
Dimensione: 22,5 x 36 cm
Pennarello cancellabile incluso



COD. 46890C - LAVAGNA CALCIO PICCOLA MAGNETICA**€ 23,63 cad**

Lavagna calcio a 11 con custodia in pelle sintetica
 Pedine e pennarello inclusi
 Cm 20x28,5
 Pvc

**COD. 46900B - LAVAGNA BASKET PICCOLA MAGNETICA****€ 26,41 cad**

Lavagna basket con custodia in pelle sintetica
 Pedine e pennarello inclusi
 cm 21,5x25,5
 Pvc

**COD. 46920F - LAVAGNA FUTSAL PICCOLA MAGNETICA****€ 23,63 cad**

Lavagna futsal/pallamano con custodia in pelle sintetica
 Pedine e pennarello inclusi
 Chiusa 21x29 cm
 Aperta 40x27 cm
 Pvc

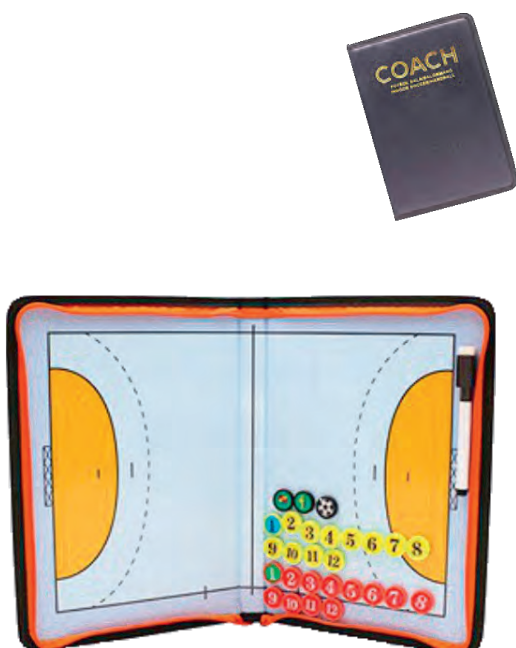
**COD. 46910V - LAVAGNA VOLLEY PICCOLA MAGNETICA****€ 23,63 cad**

Lavagna volley con custodia in pelle sintetica
 Pedine e pennarello inclusi
 Chiusa 21x29 cm
 Aperta 40x29 cm
 Pvc



58 - fitness

COD. C31900 - MATERASSINO PIEG. 50

€ 10,88 cad

Reticolato, in polietilene a cellulosa chiusa, cm 180x50x0.7 h



COD. C11800 - MATERASSINO PIEG. 50 STESO

€ 8,80 cad

Reticolato, in polietilene a cellulosa chiusa, cm 180x50x0.7 h



COD. C35100 - MATERASSINO PIEG. FIT 120

€ 8,00 cad

Reticolato, in polietilene a cellulosa chiusa, arrotolato, cm 120x50x0.6 h



COD. C35000 - MATERASSINO PIEG. FIT 120 STESO

€ 5,36 cad

Reticolato, in polietilene a cellulosa chiusa, cm 120x50x0.6 h



COD. C31700 - MATERASSINO ARR. MONO 50

€ 9,20 cad

Reticolato, in polietilene a cellulosa chiusa, arrotolato, cm 180x50x0.7 h



COD. 454040 - MATERASSINO ARR. MONO 50 STESO

€ 7,64 cad

Reticolato, in polietilene a cellulosa chiusa, arrotolato, cm 180x50x0.7 h

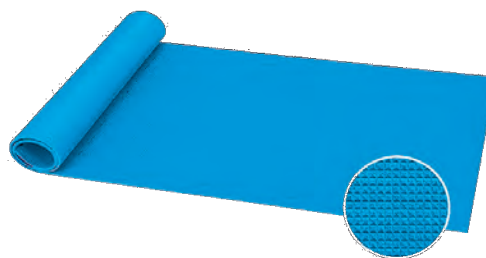

COD. C34800 - MATERASSINO ARR. FIT 140

€ 7,83 cad

Reticolato, in polietilene a cellulosa chiusa, arrotolato, cm 140x50x0.6 h



COD. 150008 - MATERASSINO COLOR**€ 22,44 cad**

Reticolato, 8 pieghe, antiscivolo, 2 elastici inclusi, cm 150x70x1 h

**COD. TY1000 - MATERASSINO YOGA****€ 14,89 cad**

Reticolato, in polietilene a cellulosa chiusa, arrotolato, cm 140x50x0.6 h

**COD. 150903 - MATERASSINO VINILE 3****€ 116,82 cad**

Cm 175x60x3 h

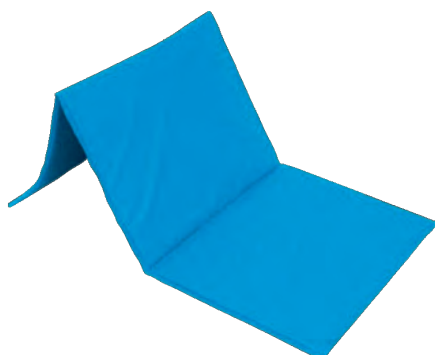
**COD. TY6000 - MATERASSINO YOGA TPE BICOLORE****€ 29,41 cad**

Reticolato, in polietilene a cellulosa chiusa, arrotolato, cm 140x50x0.6 h

**COD. C32100 - MATERASSINO ARR. SILVER****€ 10,72 cad**

Materassino ad alto comfort in polietilene a cellulosa chiusa, un lato con film illuminato e gofrato e antigraffio dall'altro, impermeabile, con isolante termico, arrotolato con elastici inclusi, cm 180x50x0.7 h



**MADE
IN
ITALY**
**COD. TY4000 - MATERASSINO YOGA BICOLORE****€ 24,31 cad**

Reticolato, in polietilene a cellulosa chiusa, arrotolato, cm 140x50x0.6 h



60 - fitness

COD. 260307 - TAPPETINO YOGA IN SUGHERO

€ 46,50 cad

Tappetino da utilizzare per esercizi a terra mat-work
Ammortizza i movimenti grazie alla superficie morbida inferiore in 100 % TPE anti-scivolo

Lato superiore 100 % sughero

Arrotolabile

Cm 183x61x0,5 h

Peso 850 gr

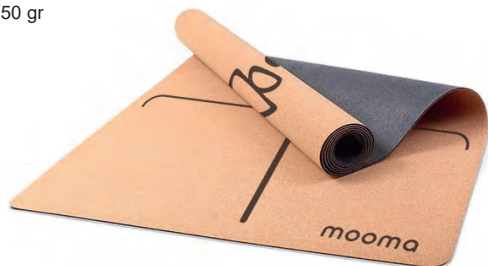

COD. 260305 - RULLO YOGA/PILATES SUGHERO

€ 30,60 cad

Rullo da utilizzare per sciogliere le tensioni muscolari, favorire la circolazione sanguigna e il rilassamento delle fibre

Da utilizzare anche per stretching e defaticamento

Peso 750 gr

Lunghezza 30 cm

Ø 9,5 cm



COD. 260306 - MATTONCINO YOGA IN SUGHERO

€ 23,97 cad

Mattoncino in sughero da utilizzare come appoggio delle mani per eseguire esercizi a terra o come supporto durante la meditazione

Cm 23x15x8 h

Peso 750 gr



COD. 260304 - SFERA YOGA IN SUGHERO

€ 5,10 cad

Sfera in 100 % sughero da utilizzare per sciogliere le tensioni muscolari, favorire la circolazione sanguigna e il rilassamento delle fibre

Peso 40 gr

Ø 6,5 cm



COD. 260303 - REFORMER PIEGHEVOLE LEGNO

€ 2.438,93 cad

Reformer adatto per la stimolazione in contemporanea della mobilità articolare, del tono muscolare, della flessibilità e della postura

Imbottitura in EVA ad alta densità con copertura in ecopelle

3 molle rosse + 1 gialla + 1 blu

Accessori inclusi: 1 box, 1 jump board, 1 poggiatesta, 2 fasce con chiusura a velcro doppia impugnatura, 2 corde per trazioni, 1 fascia in nylon per piedi con regolazione in velcro, 2 poggiaspalle, 1 cavigliera in nylon con regolazione in velcro, 2 supporti con carrucole per cavi

Peso massimo utilizzatore kg 120

Struttura in legno massello di quercia naturale

Dimensioni aperto: 255x66x63 h



COD. 905600 - CERCHIO PILATES RING**€ 21,25 cad**

Dotato di impugnature laterali interne ed esterne imbottite ed anatomiche che garantiscono il massimo comfort durante l'allenamento, ideale per molteplici esercizi isometrici dei muscoli delle gambe, delle braccia, del tronco e dell'addome, ø 38,5 cm, peso 0,33 kg

**COD. 220900 - MATTONCINO YOGA****€ 7,64 cad**

Supporto ideale per svolgere esercizi di pilates, yoga e stretching, offrono la massima stabilità ed equilibrio durante l'allenamento, misure: cm 8x15x23, PE espanso

**COD. 900100 - TUBO PILATES PRO****€ 40,70 cad**

Tubo pilates in schiuma PE, cm 91x15 ø, schiuma pe

**COD. 222500 - PALLA PILATES YOGA****€ 6,31 cad**

Palla professionale, 2 strati, ø 25 cm

**PALLA GINNICA CON POMPA****COD. 220155 - ø 55****€ 17,85 cad****COD. 220165 - ø 65****€ 20,13 cad****COD. 220175 - ø 75****€ 22,61 cad****COD. 220185 - ø 85****€ 27,13 cad**

Palla gonfiabile antiscoppio
Adatta per esercizi posturali,
di tonificazione e stretching

**PALLA GINNICA INFRANGIBILE****COD. 100104 - ø 55****€ 42,00 cad****COD. 100105 - ø 65****€ 50,96 cad****COD. 100106 - ø 75****€ 61,04 cad**

Palla professionale, 2 strati, gomma

**COD. 260301 - SLIDING DISCS****€ 16,59 coppia**

Coppia di dischi imbottiti per eseguire lo slide training per realizzare molteplici esercizi adatti a tonificare ed intensificare la muscolatura e migliorare la coordinazione
ABS + EVA
Cm 23,5x13,5

**COD. 260302 - KIT 5 FASCE IN TESSUTO****€ 16,59 kit**

Fascia ad anello in tessuto di nylon elasticizzato
Kit composto da 5 fasce a tensione media
6x75 cm



62 - fitness

COD. 250301 - PALLA MEDICA GREY KG 1

€ 30,53 cad

Palla medica in gomma senza odore, finitura esterna come i palloni basket per assicurarne il medesimo grip e maneggevolezza



COD. 250305 - PALLA MEDICA GREY KG 5

€ 61,51 cad

Palla medica in gomma senza odore, finitura esterna come i palloni basket per assicurarne il medesimo grip e maneggevolezza



COD. 250302 - PALLA MEDICA GREY KG 2

€ 38,22 cad

Palla medica in gomma senza odore, finitura esterna come i palloni basket per assicurarne il medesimo grip e maneggevolezza



COD. 250306 - PALLA MEDICA GREY KG 6

€ 67,83 cad

Palla medica in gomma senza odore, finitura esterna come i palloni basket per assicurarne il medesimo grip e maneggevolezza



COD. 250303 - PALLA MEDICA GREY KG 3

€ 42,98 cad

Palla medica in gomma senza odore, finitura esterna come i palloni basket per assicurarne il medesimo grip e maneggevolezza



COD. 250308 - PALLA MEDICA GREY KG 8

€ 81,40 cad

Palla medica in gomma senza odore, finitura esterna come i palloni basket per assicurarne il medesimo grip e maneggevolezza



COD. 250304 - PALLA MEDICA GREY KG 4

€ 49,74 cad

Palla medica in gomma senza odore, finitura esterna come i palloni basket per assicurarne il medesimo grip e maneggevolezza



COD. 180801 - PALLA MEDICA BUBBLE KG 1

€ 26,22 cad

Palla medica particolare riempita con acqua distillata, silenziosa al rimbalzo e gradevole al tatto, utilizzata per la riabilitazione e per esercizi di palleggio nel volley ø 14 cm, gomma



MADE
IN
ITALY

COD. 100113 - PALLA MEDICA NEW NEMO KG 1**€ 35,03 cad**

Con valvola rigonfiabile, ideale per allenamento e potenziamento in tutte le discipline sportive, approvato IAAF, gomma sintetica, ø 19 cm



MADE
IN
ITALY

COD. 100116 - PALLA MEDICA NEW NEMO KG 4**€ 66,65 cad**

Con valvola rigonfiabile, ideale per allenamento e potenziamento in tutte le discipline sportive, approvato IAAF, gomma sintetica, ø 24 cm

**COD. 100114 - PALLA MEDICA NEW NEMO KG 2****€ 42,47 cad**

Con valvola rigonfiabile, ideale per allenamento e potenziamento in tutte le discipline sportive, approvato IAAF, gomma sintetica, ø 19 cm



MADE
IN
ITALY

COD. 100117 - PALLA MEDICA NEW NEMO KG 5**€ 83,70 cad**

Con valvola rigonfiabile, ideale per allenamento e potenziamento in tutte le discipline sportive, approvato IAAF, gomma sintetica, ø 24 cm

**COD. 100115 - PALLA MEDICA NEW NEMO KG 3****€ 54,87 cad**

Con valvola rigonfiabile, ideale per allenamento e potenziamento in tutte le discipline sportive, approvato IAAF, gomma sintetica, ø 19 cm



MADE
IN
ITALY

COD. 100118 - PALLA MEDICA NEW NEMO KG 6**€ 97,65 cad**

Con valvola rigonfiabile, ideale per allenamento e potenziamento in tutte le discipline sportive, approvato IAAF, gomma sintetica, ø 24 cm

**COD. 180802 - PALLA MEDICA BUBBLE KG 2****€ 30,78 cad**

Palla medica particolare riempita con acqua distillata, silenziosa al rimbalzo e gradevole al tatto, utilizzata per la riabilitazione e per esercizi di palleggio nel volley ø 16 cm, gomma



MADE
IN
ITALY

COD. 180803 - PALLA MEDICA BUBBLE KG 3**€ 33,06 cad**

Palla medica particolare riempita con acqua distillata, silenziosa al rimbalzo e gradevole al tatto, utilizzata per la riabilitazione e per esercizi di palleggio nel volley ø 18 cm, gomma



64 - fitness

COD. 180610 - PALLA MEDICA OVER KG 1

€ 39,78 cad

Palla vibrata in gomma reticolata ad alto peso specifico, adatta per la simulazione tecnica del lancio, per esercizi di potenziamento, riabilitazione, aerobica ed esercizi in acqua, impugnatura soffice e robusta, galleggia, gomma reticolata, ø 19 cm



COD. 180620 - PALLA MEDICA OVER KG 2

€ 48,62 cad

Palla vibrata in gomma reticolata ad alto peso specifico, adatta per la simulazione tecnica del lancio, per esercizi di potenziamento, riabilitazione, aerobica ed esercizi in acqua, impugnatura soffice e robusta, galleggia, gomma reticolata, ø 19 cm



COD. 180615 - PALLA MEDICA OVER KG 1,5

€ 46,58 cad

Palla vibrata in gomma reticolata ad alto peso specifico, adatta per la simulazione tecnica del lancio, per esercizi di potenziamento, riabilitazione, aerobica ed esercizi in acqua, impugnatura soffice e robusta, galleggia, gomma reticolata, ø 19 cm



COD. 180630 - PALLA MEDICA OVER KG 3

€ 59,84 cad

Palla vibrata in gomma reticolata ad alto peso specifico, adatta per la simulazione tecnica del lancio, per esercizi di potenziamento, riabilitazione, aerobica ed esercizi in acqua, impugnatura soffice e robusta, galleggia, gomma reticolata, ø 19 cm



KETTLEBELL

COD. 221304 - KG 4	€ 29,41 cad
COD. 221306 - KG 6	€ 45,22 cad
COD. 221308 - KG 8	€ 58,79 cad
COD. 221310 - KG 10	€ 72,35 cad
COD. 221312 - KG 12	€ 85,92 cad
COD. 221316 - KG 16	€ 117,57 cad
COD. 221320 - KG 20	€ 146,98 cad
COD. 221324 - KG 24	€ 178,64 cad

Kettlebell pro in ghisa
Finitura superficiale antiscivolo
Verniciata a polvere



MANUBRIO GOMMATO ESAGONALE

COD. 221206 - KG 6	€ 39,34 cad
COD. 221208 - KG 8	€ 52,46 cad
COD. 221210 - KG 10	€ 65,59 cad

Manubrio esagonale con impugnatura cromata godronata
Singolo pezzo



MANUBRIO VINYL

COD. 002021 - KG 0.5	€ 3,20 cad
COD. 002022 - KG 1	€ 6,56 cad
COD. 002024 - KG 2	€ 13,12 cad
COD. 002025 - KG 3	€ 19,35 cad
COD. 002026 - KG 4	€ 25,77 cad
COD. 002027 - KG 5	€ 32,23 cad

Ghisa ricoperta in vinile
Singolo pezzo



COD. 260002 - GUANTO FITNESS ECOPELLE**€ 10,68 paio**

Guanto in ecopelle con rete tech-design traspirante
La zona del palmo è leggermente imbottita in gel con zone di contatto antiscivolo
Pollice in spugna tergisudore
Fascia blocca-polso con chiusura in velcro

**COD. 260001 - GUANTO FITNESS ECOPELLE SPANDEX****€ 15,44 paio**

Guanto in ecopelle-spandex con tessuto superiore bi-elastico
Palmo leggermente imbottito
Pollice in spugna tergisudore
Polsino regolabile con velcro

**COD. 100055 - MAGNESITE ANTISCIVOLO****€ 73,10 cad**

Magnesite a cubetti per aumentare il grip
Confezione da 8 cubetti
55 gr cadauno

**COD. 133111 - FERMADISCHI A MOLLA****€ 4,60 coppia**

Coppia di fermadischi per bilancieri e manubri, Ø 25 mm

**DISCO GHISA****COD. 222101 - KG 1****€ 5,71 cad****COD. 222102 - KG 2****€ 11,42 cad****COD. 222105 - KG 5****€ 28,56 cad****COD. 222110 - KG 10****€ 57,12 cad****COD. 222120 - KG 20****€ 107,52 cad**

Disco in ghisa nero con foro Ø 25 mm, compatibile con chiusura a vite e a farfalla, perfetto per il potenziamento della massa muscolare

**COD. 133090 - BILANCIERE CM 150****€ 54,50 cad**

Bilanciere in acciaio cromato per dischi con foro Ø 25 mm, compatibile con chiusura a vite e a farfalla, perfetto per il potenziamento della massa muscolare

**COD. 260003 - MANUBRIO CARICO SELEZIONABILE****€ 236,53 cad**

Set a carico variabile che permette un duplice uso: modalità manubrio con carico da 1,5 kg a 18 kg o modalità kettlebell con carico da 1 kg a 10 kg
In pochi istanti si trasforma da manubrio a kettlebell e con una semplice rotazione dell'impugnatura è possibile modificare il carico, garantendo massima versatilità per allenamenti a casa ma occupando pochissimo spazio

**COD. 133086 - MANUBRIO FILETTATO****€ 19,68 cad**

Manubrio filettato in acciaio cromato per dischi con foro Ø 25 mm, impugnatura centrale gommata per garantire una migliore presa, chiusura a vite, peso kg 2



66 - fitness

CAVIGLIERE APPESANTITE

COD. 220505 - KG 0.5

€ 10,85 coppia

COD. 220510 - KG 1

€ 15,84 coppia

COD. 220515 - KG 1.5

€ 20,37 coppia

COD. 220520 - KG 2

€ 27,13 coppia

COD. 220525 - KG 2.5

€ 33,93 coppia

Sovraccarichi in neoprene con fibbia di chiusura a velcro, idonee per applicazioni su polsi e caviglie, i kg sono per ogni singola cavigliera



COD. 250010 - RULLO PIENO PER MASSAGGI

€ 27,13 cad

Rullo massaggiante in EVA pieno, utilizzabile per il trattamento dei punti di contrattura, Ø 12,5, lunghezza cm 32, peso 0,45 kg

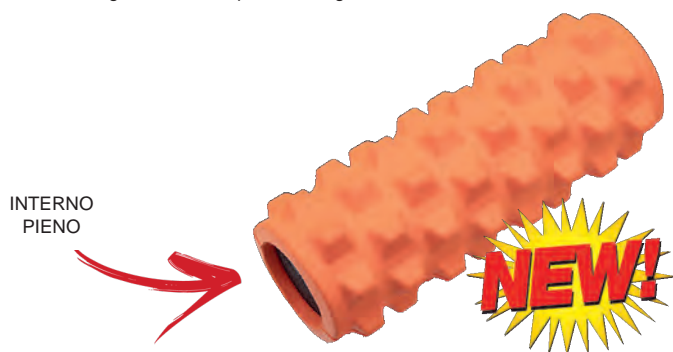

COD. 044009 - RUOTA DOPPIA PER ADDOMINALI

€ 18,89 cad

Ideale per lavorare su addominali, braccia, spalle e avambracci



COD. 201830 - ATTREZZO SUSPENSION TRAINER

€ 79,15 cad

Attrezzo per allenamento in sospensione con sistema di fissaggio regolabile e con moschettoni in acciaio
Portata massima utente 480 kg
Peso 2,6 kg
Dimensioni 20x22x6 h



COD. 260019 - CINTURA PER WEIGHTLIFTING

€ 24,65 cad

Cintura di supporto lombare per allenamenti dinamici e ad alta intensità di sollevamento pesi
Imbottitura rinforzata
Stabilizza e controlla la zona addominale riducendo la pressione sulla schiena



COD. 260020 - CINTURA PER DIP

€ 22,37 cad

Cintura con catena per attacco di zavorre per dipping o trazioni



COD. 223200 - ANELLI IN LEGNO CON STRAP

€ 47,50 paio

Anelli in legno di faggio multistrato, portata massima kg 300, Ø anello 23.5 cm, Ø impugnatura 3 cm



COD. 200470 - PARACADUTE PER POTENZIAMENTO

€ 29,95 cad

Paracadute in PI, per potenziamento individuale della corsa

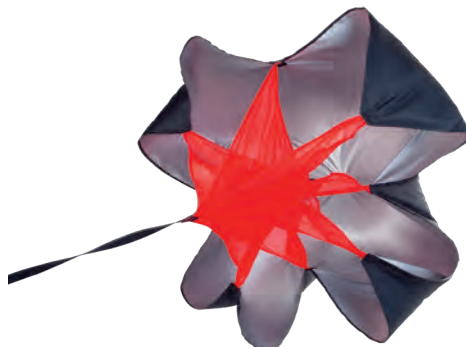

COD. 221500 - PLYOBOX LEGNO**€ 237,42 cad**

Plyobox a 3 altezze (50/60/75), struttura in legno multistrato, portata massima 150 kg 24

**COD. 221600 - PLYOBOX SOFT PRO****€ 406,98 cad**

Plyobox soft 3 in 1 (51/61/76), struttura interna in legno multistrato, imbottitura in EVA foam, copertura in vinile, portata massima 150 kg 30

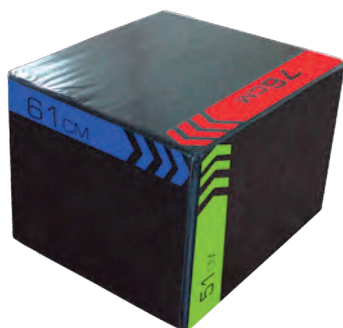
**COD. 044101 - STEP****€ 47,50 cad**

Step ideale per lavorare sulla coordinazione, sull'agilità, sulla resistenza e sui muscoli, salendo e scendendo vengono fatti lavorare moltissimi muscoli, con 2 diverse altezze per aumentare la difficoltà, facilmente trasportabile, peso massimo Kg 120, PVC antiscivolo, cm 68x28x15 h, altezze regolabili 10/15

**COD. 255150 - CORDA SALTO VELOCE****€ 22,69 cad**

Corda per salto veloce con manico in alluminio e lunghezza regolabile

**COD. 44036B - CORDA SALTO PLASTICA FLUO****€ 4,75 cad**

Corda per saltare in plastica monocolor, fluorescente, 2,75 m

**COD. 974200 - CORDA SALTO****€ 3,50 cad**

Corda salto con manici in legno, lunghezza regolabile fino a 2,80 mt

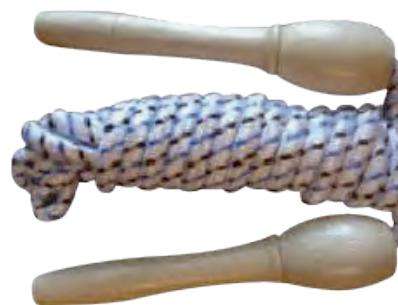
**COD. 050001 - CORDA SALTO CANAPONE****€ 8,84 cad**

Corda salto in cotone con manici in legno, ingrossamento centrale, metri 3



68 - fitness

COD. 260010 - ELASTICO RESISTENZA TUBE LIGHT

€ 17,85 cad

Elastico inguainato con moschettone a ghiera
Light 4-27 kg
Cm 0,5x0,85x170



NEW!

COD. 200490 - CORDA ELASTICA RESISTENZA

€ 51,03 cad

Mt 2.40



COD. 260011 - ELASTICO RESISTENZA TUBE MEDIUM

€ 19,21 cad

Elastico inguainato con moschettone a ghiera
Medium 9-34 kg
Cm 0,6x0,95x170



NEW!

COD. 106006 - POWER SPEED RESISTOR

€ 45,90 cad

Incrementa la forza nella gamba, da utilizzare per l'esercizio in coppia



COD. 260012 - ELASTICO RESISTENZA TUBE STRONG

€ 20,81 cad

Elastico inguainato con moschettone a ghiera
Heavy 13-45 kg
Cm 0,6x1x170



NEW!

COD. 260014 - MANIGLIE PER ELASTICO RESISTENZA

€ 12,65 coppia

Impugnatura gommata "anti-slip" con anima in nylon per garantire una massima presa ed una rotazione fluida

Anelli di aggancio con finitura cromata



COD. 260013 - ELASTICO RESISTENZA TUBE EXTRA STRONG

€ 22,17 cad

Elastico inguainato con moschettone a ghiera
Heavy-plus 18-71 kg
Cm 0,65x1,1x170



NEW!



COD. 220713 - ELASTICO POWERBAND MM 13

€ 9,04 cad

Trazione 5-10 kg, misure cm 103x1,3x0,4



COD. 220721 - ELASTICO POWERBAND MM 21

€ 14,69 cad

Trazione 7,5-20 Kg, misure cm 103x2,1x0,4



COD. 220729 - ELASTICO POWERBAND MM 29

€ 21,25 cad

Trazione 10-30 Kg, misure cm 103x2,9x0,4



COD. 220745 - ELASTICO POWERBAND MM 45

€ 32,10 cad

Trazione 20-55 Kg, misure cm 104x4,5x0,4



COD. 220764 - ELASTICO POWERBAND MM 64

€ 42,98 cad

Trazione 30-80 kg, misure cm 102x6,4x0,4



70 - fitness

COD. 210300 - ELASTICO ROTOLO LIGHT

€ 62,78 cad

Elastico utilizzato per la riabilitazione e per l'aerobica, utilizzabile per esercizi di stretching per la parte superiore del corpo e per le gambe, stimola la costruzione muscolare e migliora la forma fisica e l'allenamento del corpo, rotolo tagliabile da mt 25x15 cm, spessore 0,20 mm, lattice



COD. 671710 - ELASTICO BANDA LIGHT

€ 8,32 cad

Adatto per la riabilitazione, spessore 0,40 mm, trazione fino a 5,5 kg, mt 2,5x15 cm, lattice



COD. 210400 - ELASTICO ROTOLO MEDIUM

€ 73,99 cad

Elastico utilizzato per la riabilitazione e per l'aerobica, utilizzabile per esercizi di stretching per la parte superiore del corpo e per le gambe, stimola la costruzione muscolare e migliora la forma fisica e l'allenamento del corpo, rotolo tagliabile da mt 25x15 cm, spessore 0,25 mm, lattice



COD. 671720 - ELASTICO BANDA MEDIUM

€ 8,85 cad

Adatto per la riabilitazione, spessore 0,45 mm, trazione fino a 6,8 kg, mt 2,5x15 cm, lattice



COD. 210500 - ELASTICO ROTOLO STRONG

€ 84,93 cad

Elastico utilizzato per la riabilitazione e per l'aerobica avanzata, utilizzabile per esercizi di stretching per la parte superiore del corpo e per le gambe, stimola la costruzione muscolare e migliora la forma fisica e l'allenamento del corpo. Rotolo tagliabile da mt 25x15 cm, spessore 0,30 mm, lattice



COD. 671730 - ELASTICO BANDA STRONG

€ 9,80 cad

Adatto per la riabilitazione, spessore 0,50 mm, trazione fino a 7,8 kg, mt 2,5x15 cm, lattice



COD. 210600 - ELASTICO ROTOLO EXTRA STRONG

€ 95,95 cad

Elastico utilizzato per la riabilitazione e per l'aerobica, utilizzabile per esercizi di stretching per la parte superiore del corpo e per le gambe, stimola la costruzione muscolare e migliora la forma fisica e l'allenamento del corpo, rotolo tagliabile da mt 25x15 cm, adatto per la muscolatura già allenata, spessore 0,35 mm, lattice



COD. 671740 - ELASTICO BANDA EXTRA STRONG

€ 10,68 cad

Adatto per la riabilitazione, spessore 0,55 mm, trazione fino a 9,10 kg, mt 2,5x15 cm, lattice



COD. 222402 - ELASTICO ANELLO LIGHT**€ 3,99 cad**

Spessore 0,7 mm, trazione fino a 11-13,5 kg, cm 30x5 h, lattice

**COD. 680120 - ELASTICO CON MANIGLIE MEDIUM****€ 12,16 cad**

Elastico con maniglie adatto per la riabilitazione dei muscoli e per l'aerobica, utilizzati per esercizi di stretching per la parte superiore del corpo e gambe, stimola la costruzione muscolare e migliora la forma fisica e l'allenamento del corpo

**COD. 222403 - ELASTICO ANELLO MEDIUM****€ 4,48 cad**

Spessore 0,7 mm, trazione fino a 11-13,5 kg, cm 30x5 h, lattice

**COD. 680130 - ELASTICO CON MANIGLIE STRONG****€ 12,69 cad**

Elastico con maniglie adatto per la riabilitazione dei muscoli e per l'aerobica, utilizzati per esercizi di stretching per la parte superiore del corpo e gambe, stimola la costruzione muscolare e migliora la forma fisica e l'allenamento del corpo

**COD. 222404 - ELASTICO ANELLO STRONG****€ 4,64 cad**

Spessore 0,9 mm, trazione fino a 13,5-15,80 kg, cm 30x5 h, lattice

**COD. 181410 - ELASTICO INTENSITA' VARIABILE****€ 11,36 cad**

Con velcro cucito su entrambe le estremità, cm 20x4x2, PI



72 - propiocezione

COD. 044073 - PEDANA PUNTINATA

€ 26,83 cad

Ideale per ritrovare l'equilibrio, la propiocezione e stimolare la pianta dei piedi, rilassa e tonifica, peso massimo: 100Kg, h 7 cm, ø 33 cm, fondo antiscivolo, viene fornito con una pompa



COD. 100143 - PEDANA C1 SKIMMY

€ 64,17 cad

Pedana cilindrica rigonfiabile per riabilitazione e stimolazione propriocettiva, kg 1,20, ø 33x6 h, gomma



COD. 100144 - PEDANA C2 SUPER SKIMMY

€ 87,48 cad

Pedana cilindrica rigonfiabile per riabilitazione e stimolazione propriocettiva, kg 2,20 ø 40x9 h, gomma



COD. 241000 - PEDANA C4 REBOUND DISK

€ 52,08 cad

Pedana ideale per la propiocezione e per l'allenamento muscolare, utilizzabile sia all'interno che all'esterno, materiale molto resistente, utilizzabili anche scarpe con tacchetti, consigliata per esercizi pliometrici di cadute e ammortizzamento, con e senza rimbalzo, funzionale per il salto con arresto e cambio direzione, dimensioni: ø 40x4 h, peso: kg 1,5



COD. 100147 - MEDUSA T1

€ 151,28 cad

Pedana instabile che permette diversi esercizi come la percezione della staticità e lo sviluppo dell'equilibrio, provvista di valvola per regolare il gonfiaggio a seconda del peso, utilizzabile in entrambi i versi anche con scarpe con tacchetti, kg 3,40 ø 45 h 23, gomma doppio strato



COD. 100148 - MEDUSA T1.1

€ 200,57 cad

Pedana ad instabilità controllata grazie all'inserto rigido, strumento ideale per stimolare la percezione sensoriale della staticità, si gonfia come un semplice pallone. A seconda della pressione, può essere usata sia da un lato che dall'altro, colori assortiti, ø 45x23 h, gomma vulcanizzata

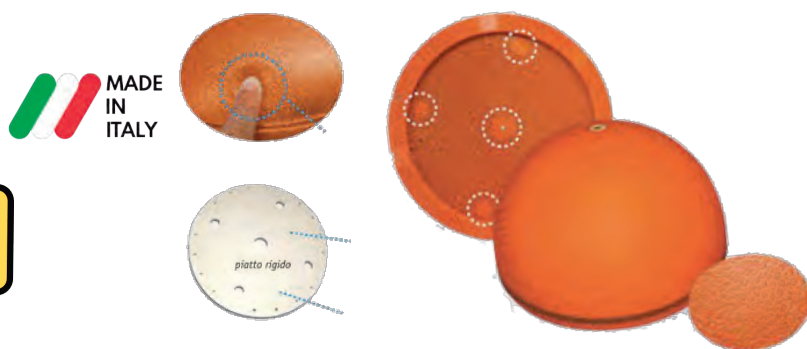

COD. 100146 - PEDANA T3

€ 272,80 cad

La parte inferiore che appoggia al terreno è stata progettata per dare il massimo del grip anche sui campi sintetici, kg 4,90, ø 55x15 h, gomma

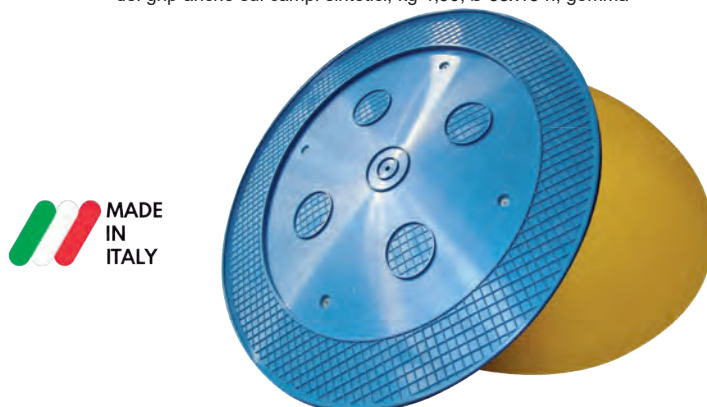

COD. 100149 - TARTARUGA T2

€ 359,29 cad

Attrezzo adatto al riscaldamento, potenziamento, riabilitazione e stimolazione propriocettiva di atleti ma anche di anziani e bambini, colori assortiti, ø 65x24 h



MADE IN ITALY



COD. 210900 - SEMISFERA BALANCE IGEL

€ 13,30 cad

Realizzata in gomma sintetica super soffice, particolare superficie a rilievi, ø 16x7 h, gomma

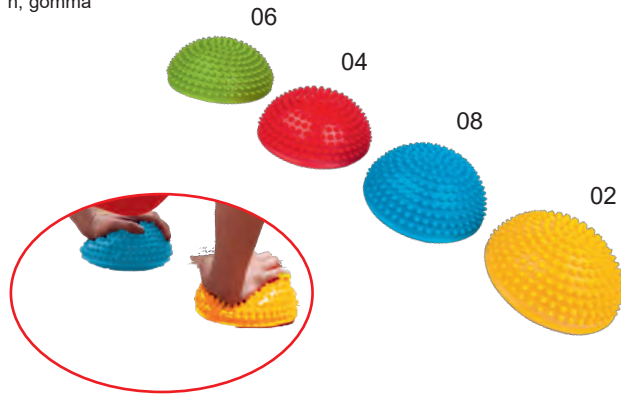

COD. 220400 - TAVOLETTA BALANCE QUADRA

€ 61,06 cad

Tavola quadra in legno 50x50 per allenamento propriocettivo, superficie antiscivolo, altezza da terra 62 mm, spessore 1,5 cm, portata massima 200 kg



COD. 220200 - PEDANA BOSU

€ 142,80 cad

Semisfera gonfiabile con base rigida, dotata di 2 maniglie e pompa per gonfiaggio, ideale per esercizi di propriocettività, coordinazione, forza e riabilitazione, ø 59 Altezza 26 cm



COD. 044071 - TAVOLETTA TONDA

€ 25,27 cad

Tavoletta per esercizi di equilibrio, ideale per l'allenamento sportivo e la riabilitazione, superficie antiscivolo, ø 40 x 8 cm h, portata massima 150 Kg, ABS



COD. 100145 - PEDANA C3 SUPERSKIMMY

€ 93,87 cad

Pedana per l'allenamento e per la riabilitazione della caviglia e del ginocchio, ideale per la rieducazione dei disturbi di equilibrio e per l'allenamento presciistico, può essere utilizzata con o senza scarpe ed è resistente ai tacchetti, colori assortiti, ø 40x9 h, gomma reticolata



COD. 144930 - TAVOLETTA TONDA LEGNO

€ 33,35 cad

Base di appoggio su emisfera, antiscivolo, ideale per l'allenamento sportivo e la riabilitazione, ø 40, legno

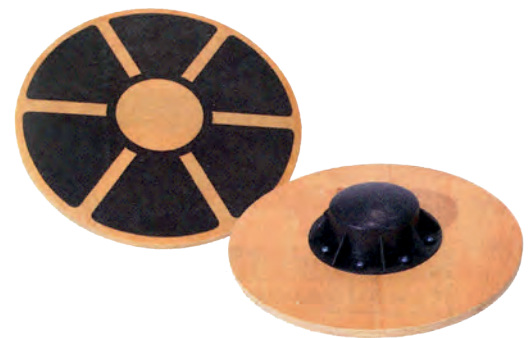

COD. 099306 - SLACKLINE

€ 114,39 cad

Cinghia elastica in poliestere da 15 metri indicata per lo slackline. La cinghia va fissata tramite una cinghia di sicurezza di 2 metri con passanti protetti

Per uso interno ed esterno
Larghezza 50 mm
Peso massimo per utente 90 kg
Carico massimo 3.000 kg



74 - tacchetti e accessori scarpe

COD. 230600 - PLANTARE ATHLETIC

€ 18,87 paio

Plantare adatto per ogni tipo di calzatura
Grande assorbimento per mantenere il piede sempre riposato
Molto resistente
Traspirante



COD. 000621 - PLANTARE ANATOMICO SPORT

€ 11,73 paio

Plantare anatomico con supporto arcoplantare e goccia metatarsale
Antibatterico
Lattice

Misure:
35/36
37/38
39/40
41/42
43/44
45/46



COD. 160333 - SOLETTA CARBONE ATTIVO

€ 2,66 paio

Sottopiede in lattice ai carboni attivi
Spessore 3,3 mm
Misura unica ritagliabile
Lattice



TALLONIERA TULI'S

COD. 190201 - SMALL

€ 20,40 paio

COD. 190202 - REGULAR

€ 20,40 paio

COD. 190203 - LARGE

€ 20,40 paio

Struttura a nido d'ape che permette di assorbire gli urti della camminata o attività fisica, riduce la pressione laterale contro il tendine d'achille, allevia numerosi disturbi quali borsite, apofisite, fascite
SMALL: fino a 40 kg
REGULAR: da 40 a 80 kg
LARGE: oltre 80 kg



TENDISCARPE A MOLLA

COD. 233537 - 35/37

€ 3,80 paio

COD. 233840 - 38/40

€ 3,80 paio

COD. 233942 - 39/42

€ 4,71 paio

COD. 234346 - 43/46

€ 4,71 paio



COD. 100054 - VASELINA FILANTE BIANCA 250 ML

€ 11,56 cad

Emulsione morbida e cremosa per idratare e rendere la pelle più elastica
Ideale per la fase di pre-fasciatura e di bendaggi



tacchetti e accessori scarpe - 75

COD. 000084 - GRASSO FOCA SCATOLA 100 ML

€ 7,68 cad

Grasso per ammorbidire e conservare calzature in cuoio naturale opaco, scarpe sportive e da trekking
Non contiene tracce animali
Scatola metallica da 100 ml



COD. 000083 - GRASSO FOCA SCATOLA 50 ML

€ 5,64 cad

Grasso per ammorbidire e conservare calzature in cuoio naturale opaco, scarpe sportive e da trekking
Non contiene tracce animali
Scatola metallica da 50 ml



COD. 140388 - LACCI SCARPE CM 180

€ 1,70 paio



COD. 000080 - GRASSO FOCA TUBETTO 50 ML

€ 4,56 cad

Grasso per ammorbidire e conservare calzature in cuoio naturale opaco, scarpe sportive e da trekking
Non contiene tracce animali
Tubetto da 50 ml



COD. 335017 - DEODORANTE SPRAY PER SCARPE

€ 12,82 cad

Deodorante per scarpe sportive
Spray ecologico
Da utilizzare per eliminare cattivi odori e purificare l'interno delle calzature
200 ml

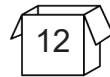

COD. 000441 - GRASSO FOCA SPRAY 200 ML

€ 10,27 cad

Grasso per ammorbidire e conservare calzature in cuoio naturale opaco, scarpe sportive e da trekking
Non contiene tracce animali
Bomboletta metallica da 200 ml



COD. 165231 - SPAZZOLA PER GRASSO

€ 3,76 cad

Cm 10,5x3,5
Legno



76 - tacchetti e accessori scarpe

CHIODI ATLETICA A PIRAMIDE

COD. 250016 - MM 6

COD. 250017 - MM 9

Blister da 12 pezzi

€ 6,15 blister

€ 6,40 blister

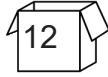

COD. 250018 - CHIAVE PER CHIEDO ATLETICA

€ 3,54 cad

Confezione da 10 pezzi

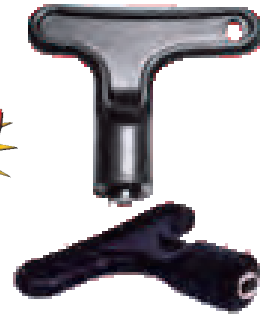

TACCHETTI NYLON METALLO TRASPARENTE

COD. 000231 - MM 11

COD. 000232 - MM 13

COD. 000233 - MM 16

Confezione da 100 pz

€ 62,00 conf

€ 62,00 conf

€ 62,00 conf



COD. 000230 - TACCHETTO NYLON METALLO 11/16

€ 9,28 blister

4 pz mm 11

4 pz mm 13

4 pz mm 16

Ny/metallo trasparente



COD. 231232 - TACCHETTO NYLON METALLO 11/13

€ 8,99 blister

8 pz mm 11

4 pz mm 13

Ny/metallo trasparente

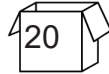

COD. 250251 - TACCHETTO ALLUMINIO TORNITO PROFESSIONAL 11/13

€ 21,00 blister

8 pz mm 11

4 pz mm 13

Alluminio



TACCHETTI NYLON METALLO NERO

COD. 221007 - MM 13

COD. 222007 - MM 16

Confezione da 100 pz

€ 43,20 conf

€ 43,20 conf



COD. 220007 - TACCHETTO NYLON METALLO 13/16

€ 7,36 blister

8 pz mm 13

4 pz mm 16

Ny/metallo nero



TACCHETTI ALLUMINIO CONICO

- COD. 000262** - MM 14 € 51,20 conf
COD. 000263 - MM 17 € 54,40 conf
COD. 000264 - MM 19 € 57,60 conf

Confezione da 100 pz



COD. 000260 - TACCHETTO ALLUMINIO CONICO 14/17

€ 8,00 blister

8 pz mm 14
4 pz mm 17
alluminio



TACCHETTI ALLUMINIO CONICO TORNITO

- COD. 000292** - MM 11 € 99,20 conf
COD. 000293 - MM 12 € 102,40 conf
COD. 000294 - MM 13 € 105,60 conf
COD. 000295 - MM 14 € 105,60 conf
COD. 000296 - MM 15 € 108,80 conf
COD. 000297 - MM 16 € 108,80 conf
COD. 000298 - MM 17 € 112,00 conf

Confezione da 100 pz
Alluminio



COD. 000290 - TACCHETTO ALL. CONICO TORNITO 11/15

€ 14,40 blister

4 pz mm 11
4 pz mm 13
4 pz mm 15
alluminio



TACCHETTI ALLUMINIO TORNITO PROFESSIONAL

- COD. 000250** - MM 11 € 112,00 conf
COD. 000251 - MM 13 € 115,20 conf
COD. 000252 - MM 15 € 118,40 conf
COD. 000253 - MM 17 € 121,60 conf

Confezione da 50 pz



COD. 000261 - TACCHETTO ALLUMINIO CONICO

€ 10,88 blister

14/17 + RONDELLE

8 pz mm 14
4 pz mm 17
12 rondelle
alluminio



TACCHETTI ALLUMINIO CONICO + RONDELLE

- COD. 000267** - MM 14 € 58,90 conf
COD. 000268 - MM 17 € 64,00 conf
COD. 000269 - MM 19 € 65,10 conf

Confezione da 100 pz
Alluminio



COD. 000265 - TACCHETTO ALLUMINIO CONICO

€ 9,92 blister

14/17 CON RONDELLE INCORP.

8 pz mm 14
4 pz mm 17
alluminio



78 - tacchetti e accessori scarpe

TACCHETTI ALLUMINIO TORNITO FILETTO

MAGGIORATO

COD. 255AD9 - MM 9

€ 115,20 conf

COD. 256AD1 - MM 11

€ 105,60 conf

COD. 257AD3 - MM 13

€ 108,80 conf

COD. 258AD5 - MM 15

€ 112,00 conf

Confezione da 50 pz
Alluminio

PRODUZIONE
SU
RICHIESTA



COD. 259AD1 - TACCHETTO ALLUMINIO TORNITO

€ 27,84 blister

9/11 FILETTO MAGGIORATO

8 pz mm 9
4 pz mm 11
alluminio

PRODUZIONE
SU
RICHIESTA



COD. 259AD3 - TACCHETTO ALLUMINIO TORNITO

€ 28,48 blister

11/13 FILETTO MAGGIORATO

8 pz mm 11
4 pz mm 13
alluminio

PRODUZIONE
SU
RICHIESTA



COD. 259AD5 - TACCHETTO ALLUMINIO TORNITO

€ 29,12 blister

13/15 FILETTO MAGGIORATO

8 pz mm 13
4 pz mm 15
alluminio

PRODUZIONE
SU
RICHIESTA



COD. 370001 - BORCHIE ACCIAIO ZINCATO

€ 17,60 conf

Confezione da 50 pz per misura
mm 7
mm 8
mm 9
mm 10
mm 11
mm 12
Acciaio zincocromato



COD. 370003 - BORCHIE LEGA LEGGERA 17

€ 24,00 conf

Confezione da 50 pz
mm 17
Lega leggera



COD. 000340 - RONDELLE ALLUMINIO SEMIBOMBATE

€ 12,48 conf

Confezione da 100 pz
Alluminio



MADE
IN
ITALY

COD. 000350 - CHIAVI PER TACCHETTI

€ 8,00 conf

Confezione da 10 pz
Acciaio



tacchetti e accessori scarpe - 79

TACCHETTI NYLON NERO

COD. 204007 - MM 13

€ 32,86 conf

COD. 205007 - MM 16

€ 33,92 conf

Confezione da 100 pz



COD. 322000 - TACCHETTI GOMMA BASE LARGA 11/13

€ 12,80 conf

8 pz mm 11

4 pz mm 13

In gomma naturale vulcanizzata da usare esclusivamente per campi ghiacciati



COD. 203007 - TACCHETTO NYLON 13/16

€ 6,40 blister

8 pz mm 13

4 pz mm 16

Ny nero

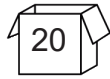

TACCHETTI GOMMA BASE STRETTA

COD. 321120 - MM 12

€ 62,40 conf

COD. 321140 - MM 14

€ 62,40 conf

Confezione da 100 pz

Gomma



COD. 000281 - TACCHETTO RUGBY 18

€ 25,60 conf

Confezione da 100 pz mm 18

alluminio



COD. 321000 - TACCHETTO GOMMA BASE STRETTA

€ 9,60 blister

12/14

8 pz mm 12

4 pz mm 14

Gomma



COD. 000280 - TACCHETTO RUGBY 18

€ 6,40 blister

16 pz mm 18

alluminio



80 - calcio

COD. 230102 - IDROPITTURA ECOLOGICA LT 2

€ 43,40 cad

Idropittura ecologica concentrata, per campi sportivi, non danneggia il manto erboso, atossica per chi la utilizza
Per un campo calcio a 11: 2 lt di idropittura in 6 lt di acqua
Per un campo rugby: 3 lt di idropittura in 9/12 lt di acqua
Compatibile con tutti i carrelli segnacampo escluso quello a calce
Conservare tra i +5° e +35°
Per una resa perfetta, utilizzare getto con un foro piccolo



 **MADE IN ITALY**



COD. 060085 - PLIFIX

€ 90,47 kit

Utile per la segnalazione di aree di gioco e oggetti interrati
Box composto da 25 pezzi + applicatore in erba sintetica



COD. 150002 - IDROPITTURA LT 14

€ 43,52 cad

Idropittura in tanica da 14 litri



1 tanica
da diluire
con acqua
in 2 taniche



 **MADE IN ITALY**

COD. 060105 - CARRELLO SEGNACAMPO A RULLO

€ 1.239,69 cad

Carrello segnacampo a rullo
Serbatoio da 12 litri
Ruote pneumatiche gonfiabili
Dotato di sistema di drenaggio per favorire la pulizia dopo l'utilizzo
Larghezza linea 10 cm
Peso carrello 19 kg



COD. 170209 - CARRELLO SEGNACAMPO A PRESSIONE**€ 1.448,03 cad**

Carrello segnacampo a caricamento automatico di pressione, per pitture liquide atossiche da diluire con acqua, per manti erbosi
 La tracciatura avviene mediante la sola spinta del carrello, non c'è batteria o motore da ricaricare
 Un meccanismo permette all'aria di essere introdotta nel flacone a pressione contenente la pittura e con pochi metri di spinta il carrello è pronto all'utilizzo
 Azionando la leva posta sul manubrio avviene la fuoriuscita della pittura in maniera costante e regolare
 Tracciatura laterale regolabile
 In dotazione due diversi getti spruzzo con differenti quantità di erogazione pittura
 Ferro verniciato

Macchina professionale

**COD. 000204 - CARRELLO SEGNACAMPO MANUALE****€ 551,62 cad**

Con pompa a pressione manuale, capacità serbatoio 10 litri, tracciante laterale regolabile, adatto a campi piccoli
 Ferro verniciato

**COD. 004600 - CARRELLO SEGNACAMPO A POLVERE****€ 481,07 cad**

Con spazzola, in acciaio verniciato

**COD. 04600S - RICAMBIO SPAZZOLA CARRELLO****€ 51,00 cad**

Per carrello segnacampo a polvere



82 - calcio

COD. M20100 - SEDUTA CON SCHIENALE

€ 43,18 cad

Da utilizzare esclusivamente per le nostre panchine calcio e calcio pro
Seduta ignifuga
Anti-UV
PP



COD. 211100 - STRUTTURA PER SEDUTE

€ 258,40 cad

PANCHINA MT 1

Solo struttura
Sedute escluse
2 posti ogni metro
Ferro



PANCHINA CALCIO PRO LX

COD. 4595L8 - MT 8 / 16 POSTI

€ 9.207,00 cad

COD. 4595L6 - MT 6 / 12 POSTI

€ 7.130,00 cad

COD. 4595L4 - MT 4 / 8 POSTI

€ 5.189,40 cad

Panchina allenatori calcio curva
Struttura in tubo di acciaio zincato smontabile

Sedili in plastica

Pannelli di rivestimento in policarbonato trasparente antiurto

Curva molto ampia

Profondità cm 180



PROTEZIONE TUBOLARE PANCHINE

COD. 325150 - CM 200

€ 153,85 cad

COD. 325160 - CM 100

€ 90,95 cad

Protezione tubolare

Gommapiuma rivestita in PVC

Ø interno cm 5

Spessore cm 5

Colori rosso, verde, blu



PANCHINA CALCIO

COD. 045931 - 2 POSTI - 106x75x205 H	€ 1.407,40 cad
COD. 045932 - 4 POSTI - 206x75x205 H	€ 2.008,80 cad
COD. 045933 - 6 POSTI - 306x75x205 H	€ 2.610,20 cad
COD. 045934 - 8 POSTI - 406x75x205 H	€ 3.348,00 cad
COD. 045935 - 10 POSTI - 506x75x205 H	€ 4.017,60 cad
COD. 045936 - 12 POSTI - 606x75x205 H	€ 4.519,80 cad
COD. 045937 - 14 POSTI - 706x75x205 H	€ 5.356,80 cad
COD. 045938 - 16 POSTI - 806x75x205 H	€ 6.026,40 cad



Struttura in tubo di alluminio mm 30x30

Pannelli di rivestimento in policarbonato alveolare traslucido con protezione anti-UV

Fianchi in policarbonato trasparente compatto antiurto

Sedili in plastica rossi

**PANCHINA CALCIO TRASPARENTE**

COD. 045951 - 2 POSTI - 106x75x205 H	€ 1.605,80 cad
COD. 045952 - 4 POSTI - 206x75x205 H	€ 2.476,90 cad
COD. 045953 - 6 POSTI - 306x75x205 H	€ 3.180,60 cad
COD. 045954 - 8 POSTI - 406x75x205 H	€ 4.318,30 cad
COD. 045955 - 10 POSTI - 506x75x205 H	€ 5.022,00 cad
COD. 045956 - 12 POSTI - 606x75x205 H	€ 5.691,60 cad
COD. 045957 - 14 POSTI - 706x75x205 H	€ 6.863,40 cad
COD. 045958 - 16 POSTI - 806x75x205 H	€ 7.533,00 cad



Struttura in tubo di alluminio mm 30x30

Pannelli di rivestimento in policarbonato trasparente compatto antiurto con protezione anti-UV

Parte inferiore in resina melaminica

Sedili in plastica rossi



84 - calcio

LEGAR

PORTE CALCIO TRASPORTABILI PROFESSIONALI SEZIONE OVOIDALE

COD. 045804 - 732x244

€ 4.987,90 coppia

COD. 458006 - 600x200

€ 4.030,00 coppia

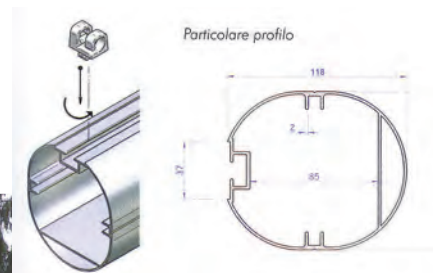

Pali traversa e base di appoggio in lega leggera a sezione ovoidale mm 100x120

Traversa divisa

Autoportanti

A norme UNI EN 748

Reti escluse



COD. 45804R - RUOTE PRO

€ 322,40 coppia

Con staffe di fissaggio

Da utilizzare esclusivamente per porte con pali a sezione ovoidale

mm 100x120

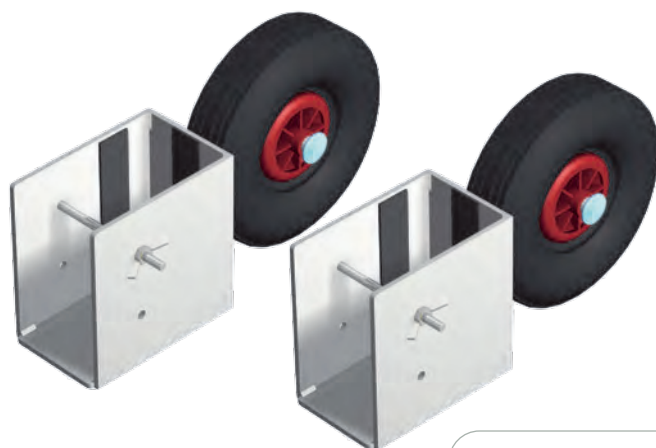

LE PORTE
TRASPORTABILI
SI VENDONO ANCHE
SINGOLARMENTE



PORTE CALCIO TRASPORTABILI IN LEGA SEZIONE OVOIDALE**COD. 45804F** - 732x244

€ 3.348,00 coppia

COD. 04581T - 600x200

€ 2.969,80 coppia

COD. 45820T - 500x200

€ 2.718,70 coppia

In lega leggera a sezione ovoidale mm 100x120

Traversa divisa

Base di appoggio a terra e sostegni posteriori reggiate in acciaio

Autoportanti

Reti escluse

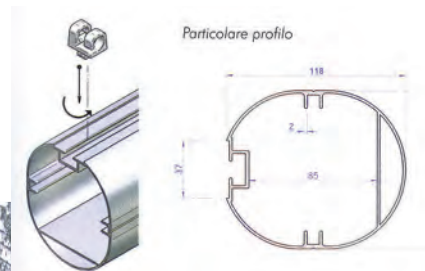
**COD. 45804R - RUOTE PRO**

€ 322,40 coppia

Con staffe di fissaggio

Da utilizzare esclusivamente per porte con pali a sezione ovoidale mm 100x120

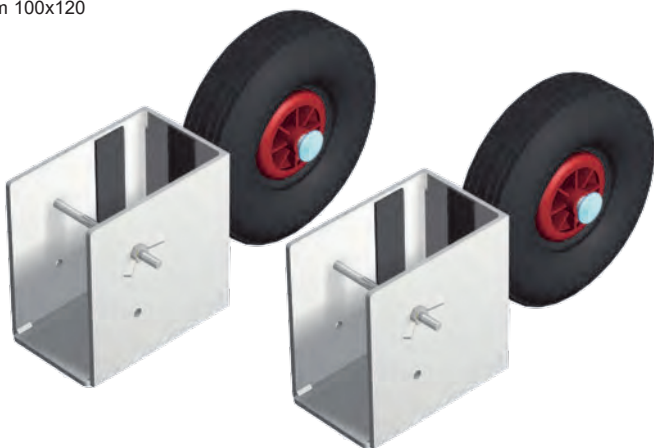
**COD. 064044 - BORSA ZAVORRA**

€ 28,42 cad

Sacca vuota da riempire con sabbia

Per la sicurezza consigliate 3 sacche per singola porta

Portata 20 kg max



LE PORTE
TRASPORTABILI
SI VENDONO ANCHE
SINGOLARMENTE



86 - calcio

PORTE CALCIO TRASPORTABILI IN LEGA SEZIONE TONDA

COD. 464460 - 600x200

€ 2.256,80 coppia

COD. 46445T - 500x200

€ 2.176,20 coppia

COD. 004644 - 400x200

€ 1.807,30 coppia

COD. 004642 - 300x200

€ 1.639,90 coppia

In lega leggera a sezione rotonda mm 80

Base di appoggio a terra e sostegni posteriori reggiate in acciaio

Autoportanti

Reti escluse



 **MADE
IN
ITALY**

COD. 244000 - RUOTE CON STAFFA

€ 250,57 coppia

Da utilizzare esclusivamente per porte con pali a sezione rotonda mm 80
Con staffa in acciaio verniciato



COD. 04640R - RUOTE

€ 182,90 coppia

Da utilizzare esclusivamente per porte con pali a sezione rotonda mm 80
Con staffa in acciaio verniciato



 **MADE
IN
ITALY**



PORTE CALCIO TRASPORTABILI IN ACCIAIO SEZIONE TONDA**COD. 230222 - 400x200****€ 1.374,01 coppia****COD. 230220 - 300x200****€ 1.235,05 coppia**

In acciaio verniciato a sezione rotonda mm 80

Base di appoggio a terra e sostegni posteriori reggiate in acciaio

Autoportanti

Acciaio

Reti escluse

**COD. 244000 - RUOTE CON STAFFA****€ 250,57 coppia**

Da utilizzare esclusivamente per porte con pali a sezione rotonda mm 80

Con staffa in acciaio verniciato

**COD. 064044 - BORSA ZAVORRA****€ 28,42 cad**

Sacca vuota da riempire con sabbia

Per la sicurezza consigliate 3 sacche per singola porta

Portata 20 kg max



88 - calcio

PORTE CALCIO FISSE

COD. 004580 - 732x244 - LEGA OVALE

€ 2.852,00 coppia

COD. 458100 - 600x200 - LEGA OVALE

€ 2.526,50 coppia



Complete di bossole da interrare
Sostegni posteriori
Reggirette in acciaio



 MADE
IN
ITALY

COD. 4580RP - KIT 12 PROTEZIONI PER RIBALTINE

€ 186,20 kit

Protezione tubolare per ribaltina alzarete
Materiale espanso rivestito
Dimensione modulo cm 200
Colore bianco



RIBALTINE ALZARETE

COD. 4580RI - per porte regolamentari € 620,00 cad

COD. 4581RI - per porte 6x2 € 573,50 cad

COD. 4582RI - per porte 5x2 € 573,50 cad

Ribaltina alzarete
Profondità cm 157 con snodi da fissare posteriormente alla base dei pali
per permettere di alzare la rete in fase di manutenzione del prato
Acciaio zincato

Altre misure prezzo a preventivo



 MADE
IN
ITALY



COD. 4580GP - GANCIO APERTO

€ 0,92 cad

Per porte calcio
Venduto in confezioni da 100 ganci
Ny

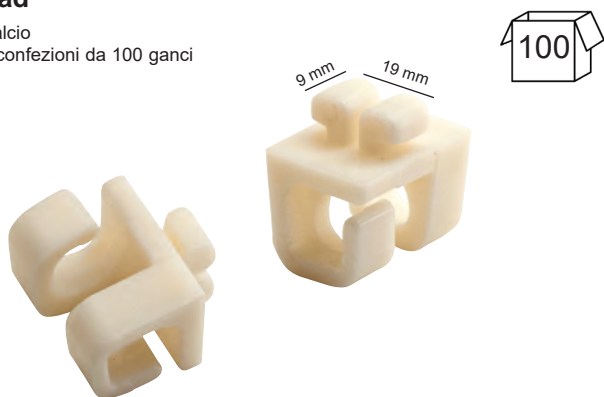

COD. 260015 - GANCIO APERTO BIANCO

€ 0,80 cad

Per porte calcio
Venduto in confezioni da 100 ganci
Ny

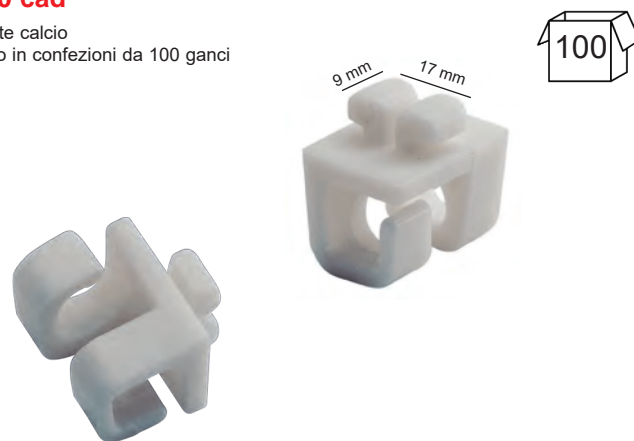

COD. 4580NW - GANCIO CHIUSO

€ 0,92 cad

Per porte calcio
Venduto in confezioni da 100 ganci
Ny

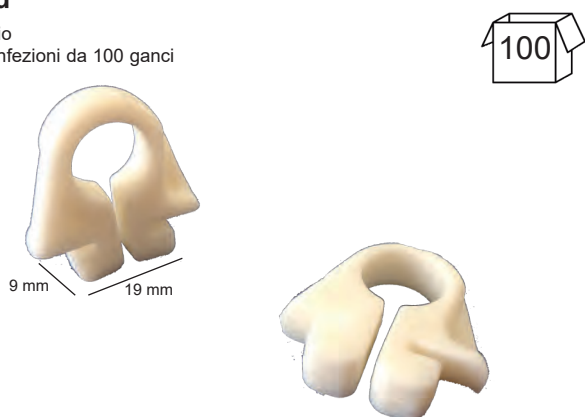

COD. 261051 - GANCIO CHIUSO TARTARUGA

€ 0,62 cad

Per porte calcio
Venduto in confezioni da 100 ganci
Ny

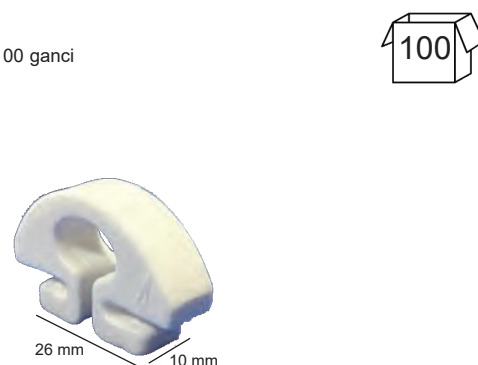

COD. 160353 - GANCIO APERTO CON VITE

€ 1,55 cad

Per porte calcio
Viti comprese
Venduto in confezioni da 100 ganci
Ny

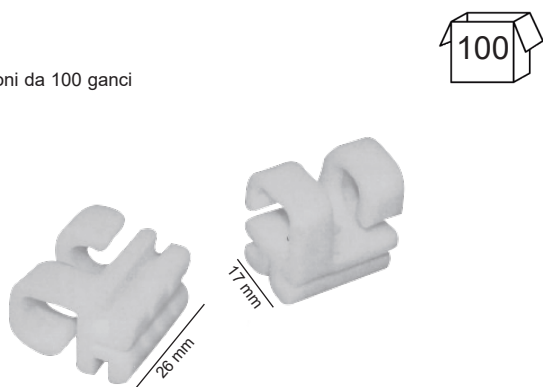

COD. 680011 - GANCIO APERTO BASE ROTONDA

€ 1,49 cad

Per porte calcio
Venduto in confezioni da 100 ganci
Ny



COD. 200001 - GANCIO APERTO VERDE

€ 1,63 cad

Per porte calcio
Venduto in confezioni da 100 ganci
Ny

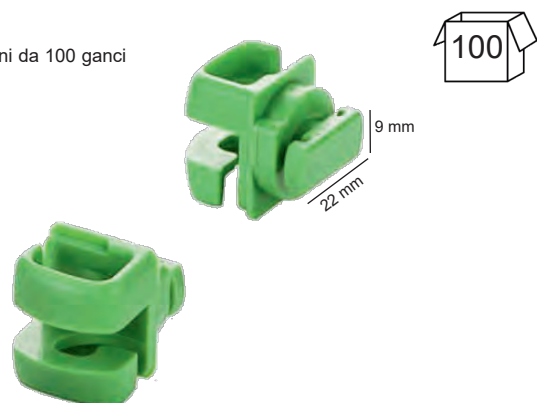

COD. 268060 - GANCIO APERTO CON VITE GRIGIO

€ 1,58 cad

Per porte calcio
Venduto in confezioni da 100 ganci
Ny

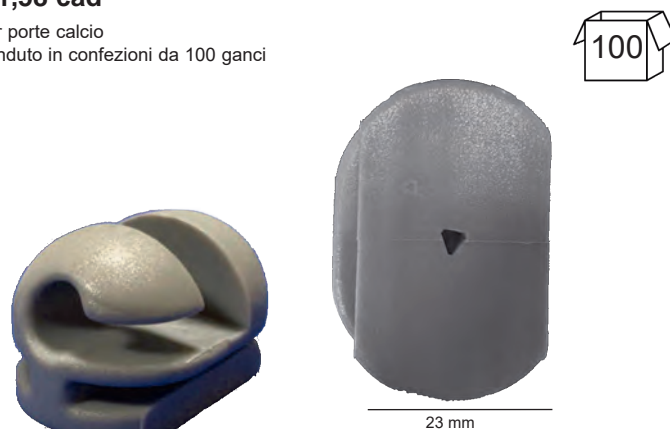

COD. C00160 - RETE REGOLAMENTARE QUADRA

€ 360,47 coppia

Maglia quadra annodata mm 140
kg 12,50
Classe A
Pe

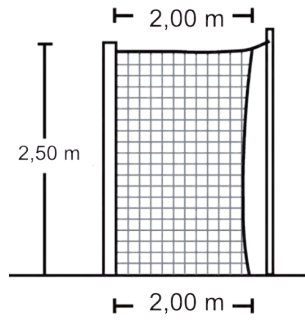

COD. CA0010 - RETE REGOLAMENTARE ESAGONALE

€ 254,40 coppia

Maglia esagonale mm 120
Rete con trattamento anti-UV
Ideale per porte trasportabili

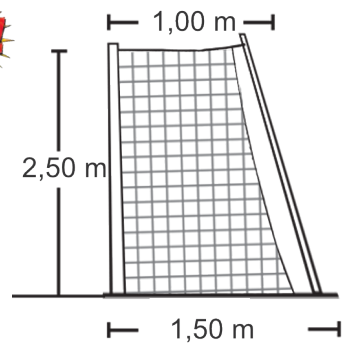
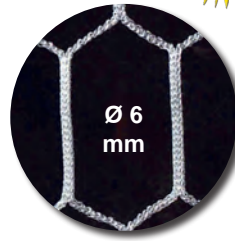

COD. 0C0019 - RETE REGOLAMENTARE QUADRA

€ 234,26 coppia

Maglia quadra annodata mm 140
Ideale per porte trasportabili
Kg 6,90
Classe B
Pe

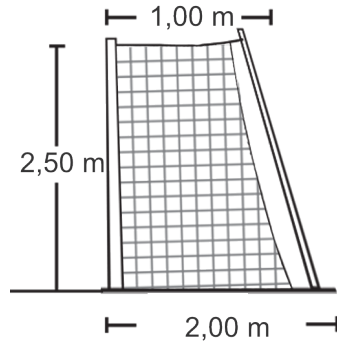
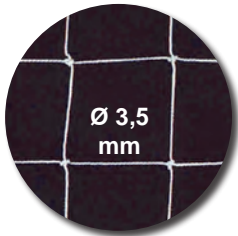

COD. CA0004 - RETE REGOLAMENTARE QUADRA

€ 270,30 coppia

Maglia quadra annodata mm 120

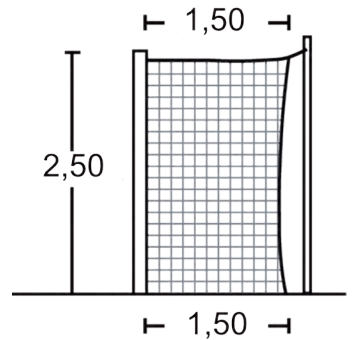

COD. CA0012 - RETE REG. QUADRA COLORATA

€ 280,50 coppia

Maglia quadra annodata mm 120
Rete con trattamento anti UV
Ppht

Bianco/rosso
Bianco/verde
Bianco/royal
Giallo/rosso
Giallo/verde
Giallo/royal

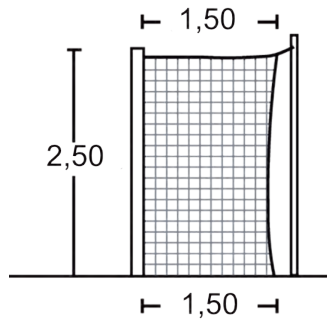
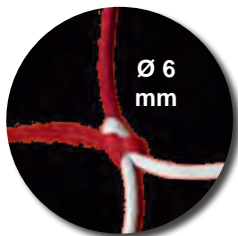

COD. 00C004 - RETE REGOLAMENTARE ESAGONALE

€ 289,34 coppia

Maglia quadra mm 120
riquadro maglia mm 6

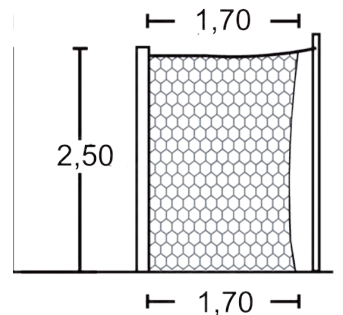
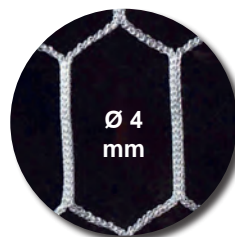

14

76

18

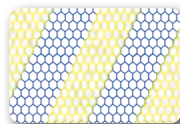
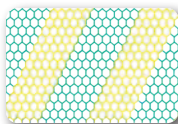
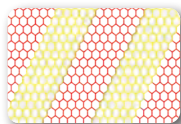

24

86

28



reti 6x2

COD. 000170 - RETE CALCIO QUADRA 6x2

€ 157,76 coppia

Maglia quadra annodata mm 130
Kg 4,60
Pe

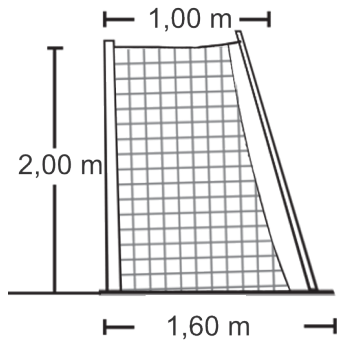
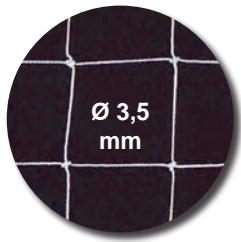

reti 5x2

calcio - 91

COD. 000171 - RETE CALCIO QUADRA 5x2

€ 167,62 coppia

Maglia quadra annodata mm 140
Kg 4,50
Pe

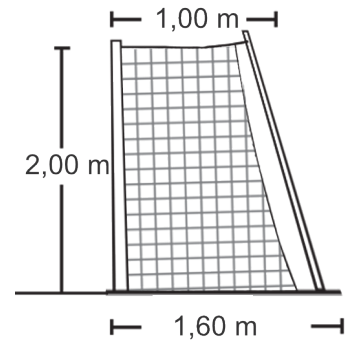
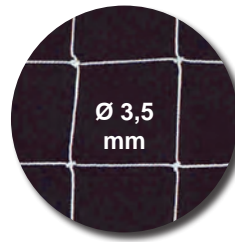

COD. 169000 - RETE CALCIO QUADRA ECONOMICA 6x2

€ 131,24 coppia

Maglia quadra annodata mm 140
Kg 3,40
Pe

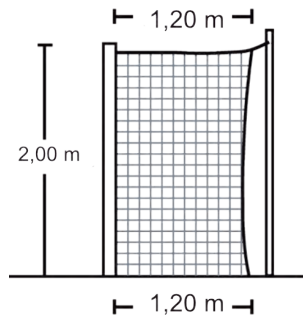
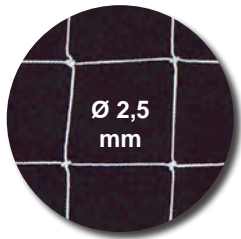

COD. 168000 - RETE CALCIO QUADRA ECONOMICA 5x2

€ 119,68 coppia

Maglia quadra annodata mm 140
Pe

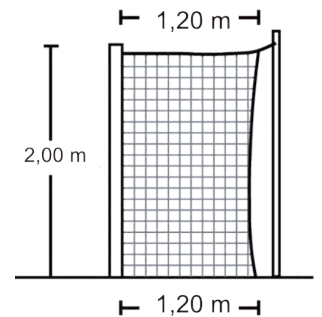
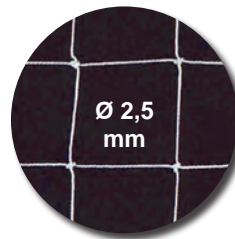

COD. CA0008 - RETE CALCIO ESAGONALE 6x2

€ 178,50 coppia

Maglia esagonale mm120
Rete con trattamento anti UV
Ppht

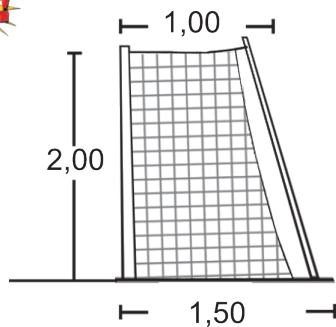
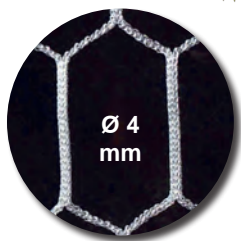

COD. CA0006 - RETE CALCIO ESAGONALE 5x2

€ 158,10 coppia

Maglia esagonale mm 120
Rete con trattamento anti UV
Ppht

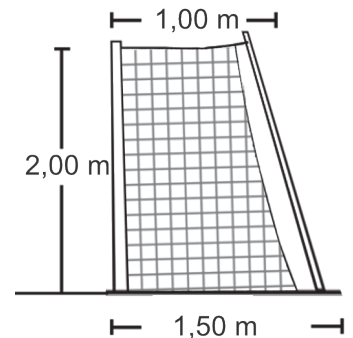
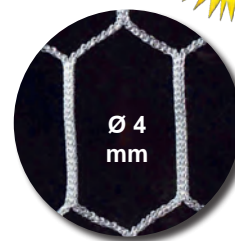

COD. 170200 - RETE CALCIO QUADRA 6x220

€ 169,66 coppia

Maglia quadra annodata mm120
Per porte fuori misura
Pe

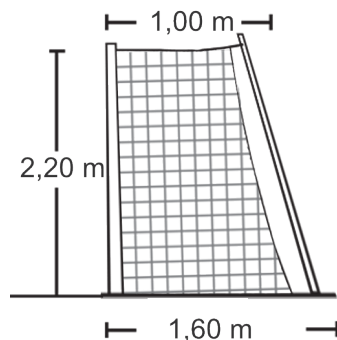
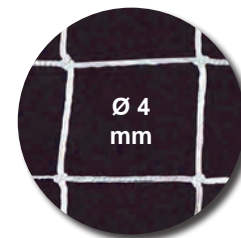

COD. 153000 - RETE CALCIO ESAGONALE 6,5x2,5

€ 245,82 coppia

Maglia esagonale annodata mm120
Per porte fuori misura
Pe

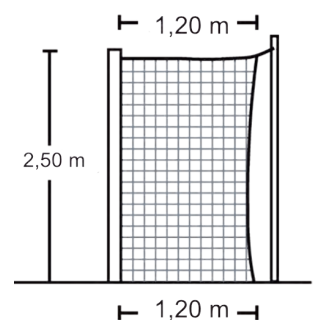
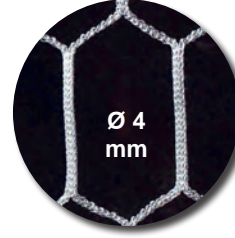

92 - calcio

reti 4x2

reti 3x2

COD. 000166 - RETE CALCETTO QUADRA 4x2

€ 132,60 coppia

Maglia quadra annodata mm 130
Kg 3,60
Pe

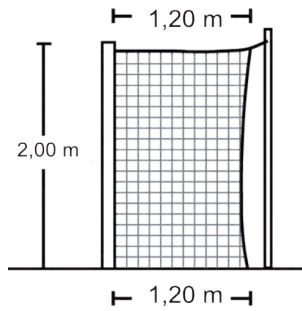
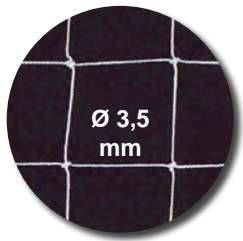

COD. 000159 - RETE CALCETTO QUADRA 3x2

€ 129,20 coppia

Maglia quadra annodata mm 100
Kg 3,60
Classe B
Pe

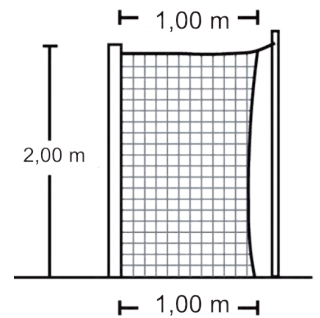
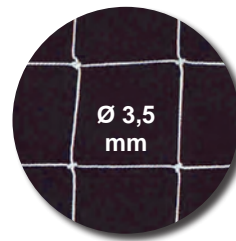

COD. 167000 - RETE CALCETTO QUADRA ECO 4x2

€ 103,02 coppia

Maglia quadra annodata mm 140
Kg 2,90
Pe
Consigliata per uso domestico

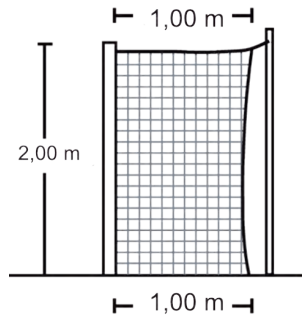
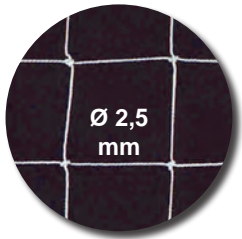

COD. 149000 - RETE CALCETTO QUADRA ECO 3x2

€ 101,32 coppia

Maglia quadra annodata mm 100
Kg 2,60
Pe
Consigliata per uso domestico

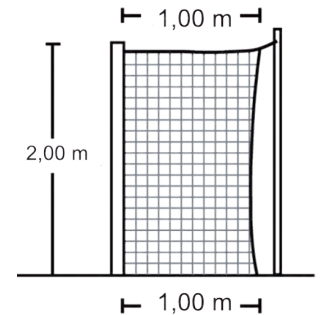
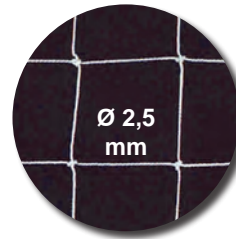

COD. CA0009 - RETE CALCETTO ESAGONALE 4x2

€ 150,45 coppia

Maglia esagonale mm 120
Rete con trattamento anti UV
Ppht

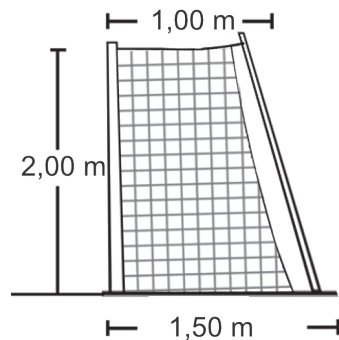

COD. 158000 - RETE CALCETTO QUADRA PRO 3x2

€ 179,18 coppia

Maglia quadra annodata mm 100
Kg 6,50
Classe A
Pe
Colore rosso

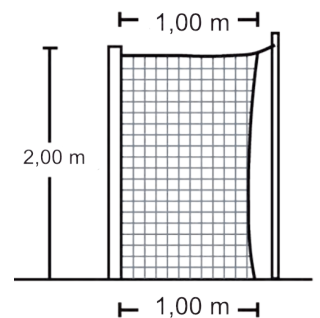

COD. CL0026 - RETE CALCETTO ESAGONALE 3x2

€ 114,75 coppia

Maglia esagonale mm 120
Rete con trattamento anti UV
Ppht

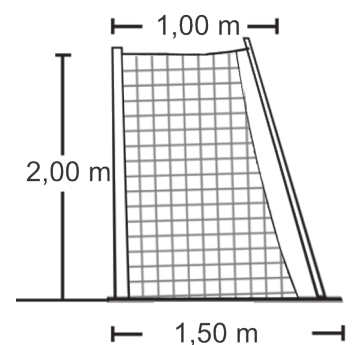

COD. 430100 - RETE PROTEZIONE CAMPI MM 100**€ 3,60 mq**

Con corda perimetrale, larghezza quadro rete mm 100, \varnothing MM 3, KG/ m² 50 gr, PE
Misure a richiesta - prezzo al metro quadro

**COD. 440045 - RETE PROTEZIONE CAMPI MM 45****€ 6,32 mq**

Con bordatura perimetrale, larghezza quadro rete mm 45, \varnothing MM 3, KG/ m² 100 gr, PE
Misure a richiesta - prezzo al metro quadro

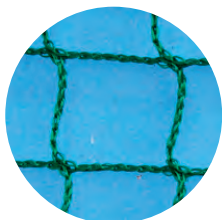
**COD. 460140 - RETE COPERTURA CAMPI MM 140****€ 3,06 mq**

Con bordatura perimetrale, larghezza quadro rete mm 140, \varnothing MM 3, KG/ m² 40 gr, PE
Misure a richiesta - prezzo al metro quadro

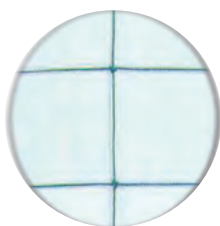
**COD. 00P220 - RETE BEACH SOCCER ESAGONALE****€ 219,47 cad**

Maglia esagonale mm120
cm 550x220
Pp

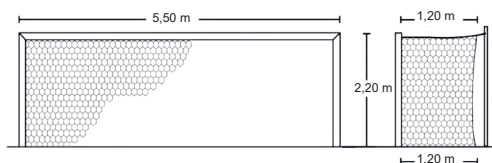
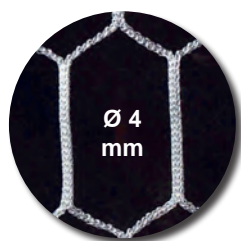
**COD. 220058 - MORSETTI PER RETE PROTEZIONE****€ 0,46 cad**

Morsetti mm.6
Acciaio zincato

**COD. 220067 - TENDITORE PER CAVO****€ 3,67 cad**

Tenditore a due occhielli mm.10
Acciaio zincato

**COD. 220069 - FALSA MAGLIA PER RETE PROTEZIONE****€ 0,46 cad**

False maglie mm.3,5
Acciaio zincato

**COD. 220054 - CAVO ACCIAIO****€ 3,04 al metro**

Fune \varnothing mm.5 per tensione reti di protezione
Acciaio zincato ricoperto in PVC



94 - calcio

COD. 064203 - PORTICINE POP-UP 120x90

€ 99,90 coppia

Porta da calcio trasportabile e molto facile da montare
Perfetta per campi da calcio, palestre e giardini
Resistente a tutte le temperature meteorologiche
Acciaio
Borsa per il trasporto e rete incluse



COD. 064169 - PORTICINA QUICK FIRE 300x200

€ 293,93 cad

Porta multisport pieghevole, leggera e resistente.
Fissaggio tramite picchetti inclusi.
Fornito con borsa per il trasporto.
Dimensione: 300x200x100cm
Peso kg 8,5



COD. 063344 - BASE PER PORTA E SAGOMA

€ 85,14 cad

Base 2 in 1 per porte e sagome con puntale
Gli artigli da un lato permettono di agganciare la base alla porticina per impedirne il ribaltamento
Compatibile con le porticine con tubo da \varnothing 40
Maniglie laterali per facilitare il trasporto
Peso 12 kg
Dimensioni: 50x32x11,2 h



COD. 064168 - PORTICINA QUICK FIRE 240x150

€ 227,63 cad

Porta multisport pieghevole, leggera e resistente.
Fissaggio tramite picchetti inclusi.
Fornito con borsa per il trasporto.
Dimensione: 244x152x80cm
Peso kg 5



COD. 64205U - PORTICINA PIEGHEVOLE FERRO 120x80

€ 122,59 cad

Tubo \varnothing 32 mm
Pieghevole
Dimensioni: 120x80x60 cm
Rete inclusa



COD. 64205F - RETE RICAMBIO PORTICINA 64205U

€ 26,83 cad

Rete di ricambio per porticina 64205U
Incluse 20 clip per il fissaggio

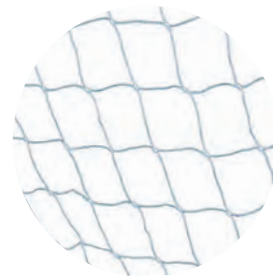

COD. 00061F - PORTICINA CON SUPPORTO 150x110

€ 125,39 cad

Tubo \varnothing 40 mm
cm 150x110 h
Capovolta si ottiene
una porticina 150x80 h
Pvc
Rete inclusa



COD. C15700 - RETE RICAMBIO PORTICINA 00061F

€ 27,88 cad

Rete di ricambio per porticina 00061F
Maglia esagonale 120 mm
 \varnothing 4 mm
PPHT

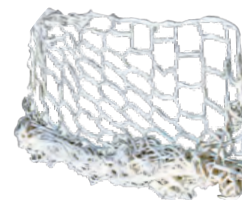

COD. 000214 - PORTICINA PRO FERRO 150x110

€ 414,53 cad

Tubo ø 80 mm
cm 150x110 h
Ferro verniciato
Rete inclusa



COD. 21400R - RETE RICAMBIO PORTICINA 000214

€ 39,44 cad

Rete di ricambio per porticina 000214

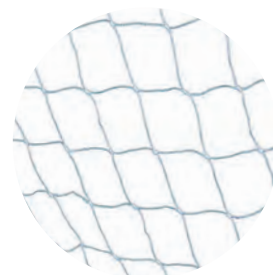

COD. 180218 - PORTICINA PRO FERRO 90x60

€ 316,51 cad

Tubo ø 80 mm
cm 90x60 h
Ferro verniciato
Rete inclusa



COD. 21800R - RETE RICAMBIO PORTICINA 180218

€ 28,90 cad

Rete di ricambio per porticina 180218

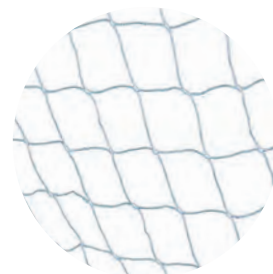

COD. 000215 - PORTICINA FERRO 150x110

€ 143,72 cad

Tubo ø 30
cm 150x110 h
Ferro verniciato
Rete inclusa



COD. 21500R - RETE RICAMBIO PORTICINA 000215

€ 18,70 cad

Rete di ricambio per porticina 000215

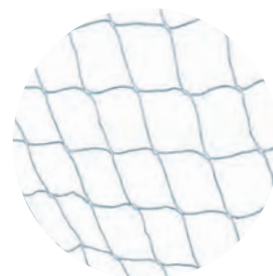

COD. 150217 - PORTICINA FERRO 90x60

€ 116,31 cad

Tubo ø 30
cm 90x60 h
Ferro verniciato
Rete inclusa



COD. 21700R - RETE RICAMBIO PORTICINA 150217

€ 10,03 cad

Rete di ricambio per porticina 150217

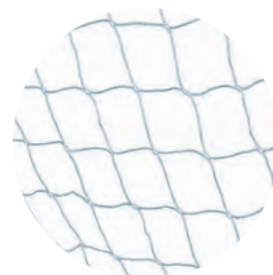

96 - volley

COD. 000P14 - ANTENNE VOLLEY DIVISE IN 2 PEZZI

€ 46,19 paio

Vetroresina



COD. 676700 - ARGANELLO A CRICCHETTO

€ 64,60 cad

Ricambio per impianto volley 06746T



COD. 000P15 - TASCHE PORTA ANTENNE VOLLEY

€ 18,14 paio

Tasche porta antenne divise



COD. 676710 - ARGANELLO A CREMAGLIERA

€ 231,20 cad

Ricambio per impianto volley 006748
Completo di maniglia



COD. P16000 - ANTENNE VOLLEY INTERE

€ 57,63 paio

Coppia di antenne volley professionali
Pezzo intero



COD. 250015 - PORTA ANTENNE VOLLEY

€ 45,60 paio

DA COMPETIZIONE

Coppia di porta antenne volley
Da utilizzare esclusivamente con antenne intere

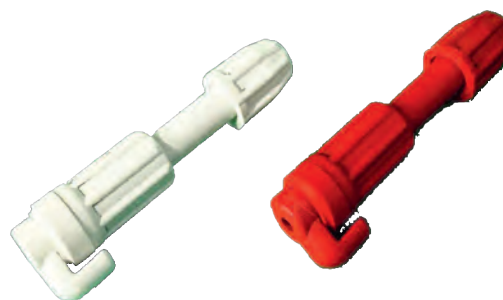

NEW!



COD. 006748 - IMPIANTO VOLLEY TRALICCIO**€ 1.723,60 cad**

Tubo di alluminio a sezione ovoidale mm 122x103
Rinforzato internamente
Con tendirete a cremagliera interno al palo
Fissaggio a terra con tirafondi
Modello omologabile antinfortunistico
Alluminio



MADE
IN
ITALY

COD. 223600 - PROTEZIONE IMPIANTO VOLLEY**€ 1.004,40 cad** **TRALICCIO**

Imbottitura di protezione per impianto volley a traliccio art. 006748
Con rivestimento in pvc
Chiusura con velcro
h 200 cm
Eliocell espanso/pvc

**COD. 06746T - IMPIANTO VOLLEY FISSO****€ 570,40 cad**

Con bossole da interrare
Formato da 2 montanti in tubo di acciaio zincato
Diametro mm 76 altezza cm 255 fuori terra
Tendirete a cricchetto
Utilizzabile anche per tennis
Acciaio
Rete esclusa

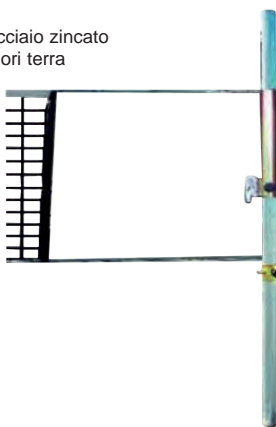

MADE
IN
ITALY

COD. 208300 - PROTEZIONE IMPIANTO VOLLEY FISSO**€ 683,40 cad**

Imbottitura di protezione per impianto volley art. 06746T
Con rivestimento in pvc
Chiusura con velcro
h 200 ø 12 cm
Eliocell espanso/pvc

**COD. 06740R - IMPIANTO VOLLEY TORNEO****€ 1.137,70 cad**

Impianto formato da 2 montanti a traliccio in acciaio verniciato
Con doppia controvenatura
Palo di scorrimento zincato
Completo di tendirete a cricchetto
Fissaggio a pavimento con attacchi a vite
Trasportabile
Acciaio
Rete esclusa



MADE
IN
ITALY

COD. 06752T - IMPIANTO VOLLEY A PARETE**€ 489,80 cad**

Impianto pallavolo a parete in tubo di acciaio zincato
Predisposto con piastre per il fissaggio a tasselli
Acciaio zincato
Rete esclusa

**COD. 006780 - IMPIANTO MINIVOLLEY-BADMINTON****€ 680,00 cad**

Trasportabile su ruote
Zavorrato



MADE
IN
ITALY

**COD. P18000 - CAVO ACCIAIO PER RETE VOLLEY****€ 20,23 cad**

Cavetto in acciaio per ricambio su reti da volley
cm 40x23
Acciaio



98 - volley

COD. 222800 - SEGNAPUNTI VOLLEY SCHOOL 0/30

€ 52,50 cad

Segnapunti volley da tavolo
Numeri da 0 a 30
cm 54x20x30 h



COD. 053010 - SEGNAPUNTI VOLLEY 0/50

€ 119,00 cad

Segnapunti volley da tavolo
Numeri da 0 a 50
cm 55x22x30 h



COD. 006784 - PALETTE SOSTITUZIONE GIOCATORI

€ 296,80 kit

Kit 18 pezzi



COD. 675300 - BALL-CATCHER

€ 936,20 cad

Contenitore porta palloni incluso
Altezza regolabile da cm 170 a 300
Canestro inclinabile
ferro verniciato



COD. 006768 - PALCHETTO ARBITRO VOLLEY

€ 697,50 cad

Palchetto per arbitro pallavolo
Struttura in tubo di acciaio verniciato
Smontabile
Con ruote per il trasporto
h 200 ø 12 cm



COD. 06768S - PALCHETTO ARBITRO VOLLEY SPECIAL

€ 880,60 cad

Palchetto per arbitro pallavolo seduto ed in piedi
Struttura in tubo di acciaio verniciato
Smontabile
Con ruote per il trasporto
h 200 ø 12 cm



COD. 00P200 - RETE VOLLEY FIPAV**€ 211,82 cad**

Maglia quadra annodata mm 100 \varnothing 3,5 mm
 Nella parte superiore cavo di acciaio ricoperto da banda doppia in pvc bianco cm 7
 Nella parte inferiore banda cm 5 attraverso la quale passa una corda che la mantiene tesa e la fissa ai pali
 Lateralmente una fettuccia di 3 cm di colore nero custodisce le stecche di tensione
 Cm 950x100 h, cavo acciaio mt 12,50, fettuccia mt 2,20
 Pe
 Antenne e tasche escluse
 A norma FIPAV

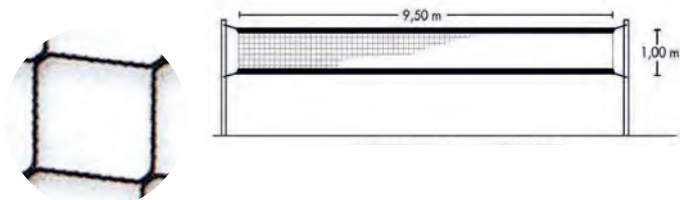
**COD. P19000 - RETE BEACH VOLLEY****€ 172,38 cad**

Maglia quadra mm 100
 \varnothing 3,5 mm
 Nastro in pvc doppio mm 75
 cm 850x100 h
 Pp

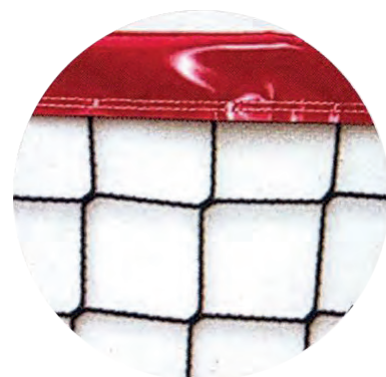
**COD. 00P090 - RETE VOLLEY ECO****€ 105,06 cad**

Maglia quadra annodata mm 100 \varnothing 2,5 mm
 Nella parte superiore cavo di acciaio
 Ricoperto da banda in pvc cm 5
 cm 950x100 h
 Pe

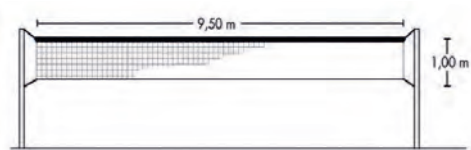
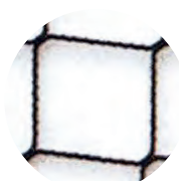
**COD. 000P17 - KIT SEGNALETICA CAMPO BEACH VOLLEY****€ 98,26 kit**

Composto da 4 nastri in polipropilene
 h 5 cm
 8 picchetti
 8 elastici
 mt 16x8

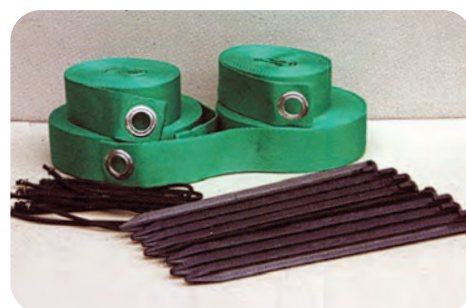
**COD. 00P140 - RETE SUPER MINIVOLLEY****€ 42,50 cad**

Maglia quadra mm 100
 \varnothing mm 2,5
 Banda colorata in polipropilene cm 4 parte superiore
 Bordatura laterale di rinforzo
 cm 650x100 h
 Pp

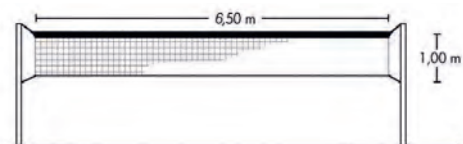
**COD. 00P221 - KIT SEGNALETICA CAMPO BEACH SOCCER****€ 229,67 kit**

Composto da:
 2 nastri da 37 mt
 2 nastri da 28 mt
 8 picchetti
 8 elastici
 Pl

**COD. 00P130 - RETE MINIVOLLEY****€ 33,83 cad**

Maglia quadra mm 100
 \varnothing mm 2,5
 Banda colorata in polipropilene cm 4 parte superiore
 Bordatura laterale di rinforzo
 cm 500x70 h
 Pp

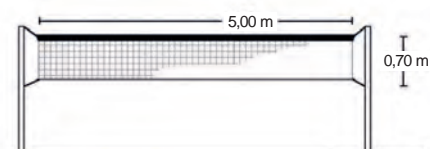

100 - basket

COD. 106000 - CANESTRO RECLINABILE

€ 382,08 cad

Con anello in tondo pieno
Sistema di aggancio rete
mediante filo in acciaio su tubo
Protezione antinfortunistica
in gomma brevettata
Attestato di conformità TUV EN 1270
acciaio verniciato
Rete esclusa



COD. 000122 - RETE BASKET ACCIAIO

€ 22,95 cad

Acciaio zincato



COD. 000102 - CANESTRO FERRO

€ 38,25 cad

acciaio verniciato
Rete esclusa



COD. 00B050 - RETE BASKET NYLON

€ 19,04 coppia

ø 6
Nylon



COD. 000103 - CANESTRO FERRO RINFORZATO

€ 62,80 cad

Acciaio verniciato
Rete esclusa



COD. 222960 - RETE BASKET COTONE

€ 32,47 coppia

ø 7
Cotone



COD. 000105 - CANESTRO FERRO ZINCATO

€ 86,70 cad

Ferro zincato a caldo
Ultrasistente
Per esterno
Rete esclusa



**MADE
IN
ITALY**



KIT BASKET DOUBLE

COD. ABK124 - ROYAL/BIANCO	€ 23,00 kit
COD. ABK114 - NAVY/BIANCO	€ 23,00 kit
COD. ABK154 - ROSSO/BIANCO	€ 23,00 kit
COD. ABK134 - NERO/BIANCO	€ 23,00 kit
COD. ABK174 - VERDE/BIANCO	€ 23,00 kit

Tessuto microforato in poliestere, reversibile, pantaloncino con laccio in vita
Taglie da YS a 2XL



81



41



91



71



61

COD. 00116C - TABELLONE MINIBASKET 120x90

€ 289,00 cad

Per esterno
Escluso telaio e fori per aggancio canestro
cm 120x90x1
Resina melaminica



MADE
IN
ITALY

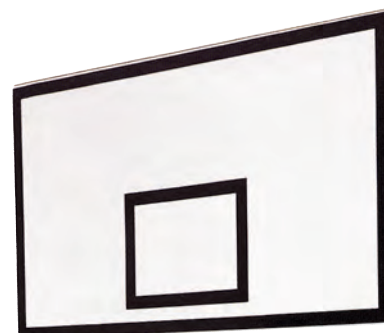

COD. 064003 - TABELLONE BASKET MURALE

€ 180,31 cad

Composto da un pannello rettangolare in HDPE, un cerchio in acciaio rosso e una rete in PP bianca da 1,3 mm.

Fornito con staffa in acciaio, viti, rondelle e tasselli

Dimensioni del pannello: 71x109x4 cm

Uso domestico interno ed esterno



102 - basket

COD. 064002 - IMPIANTO BASKET REGOLABILE SR

€ 403,58 cad

Canestro da basket mobile regolabile in 6 altezze (da 2,30m a 3,05m).
Facile da spostare con le rotelle.
Base zavorrata riempibile di acqua o sabbia.
Fornito con rete in PP bianco da 1,3 mm.
Uso domestico interno ed esterno.



COD. 005696 - CANESTRO TRASPORTABILE

€ 418,50 cad

Trasportabile su due ruote
Zavorra da 30 kg
Tabellone 60x90
Regolabile in altezza da 200 a 260 cm
Ferro zincato

 **MADE
IN
ITALY**



COD. 064010 - CANESTRO BABY BASKET

€ 95,15 cad

Destinato ai bambini, composto da una base ampia e un cestino.
Tubo ø 21mm
Rete in polipropilene ø 4mm
Cerchio ø 41cm
Base ø 77cm H85 cm
Rete inclusa

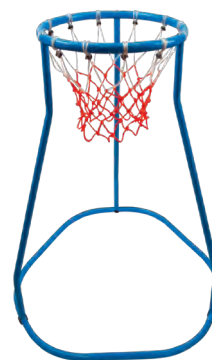

85 cm

COD. 05696M - CANESTRO MULTIPLAY

€ 1.137,70 cad

Trasportabile su due ruote
Asta in alluminio nervata
Altezza regolabile fino a 305 cm
Tabellone cm 109x70
Canestro di colore nero completo di retina
Ferro verniciato



 **MADE
IN
ITALY**

COD. 063499 - SAGOMA GONFIABILE BASKET

€ 125,80 cad

Sagoma gonfiabile ideale per allenamento di basket e handball
Base riempibile con acqua per una maggiore stabilità e utilizzo sicuro
Facile da spostare grazie alle maniglie laterali
Torna sempre nella posizione verticale iniziale autonomamente
Larghezza 60 cm
Altezza 2,4 mt
Pvc

NEW!



COD. 053008 - SEGNAPUNTI BASKET 0/199**€ 102,00 cad**

Segnapunti da tavolo basket
Numeri da 0 a 19
cm 55x22x30 h

**COD. 063110 - KIT PALETTE FALLI BASKET****€ 37,96 kit**

Palette regolamentari in plastica flessibile inalterabile stampate su entrambi i lati
Numeri da 1 a 4 in nero e numero 5 in rosso
Dimensioni: 13 x 32 cm

**COD. 063112 - INDICATORI FALLI SQUADRA BASKET****€ 28,42 coppia**

Coppia di indicatori falli basket
Dimensioni cm 21x15
Pvc

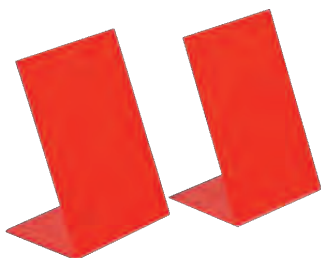
**COD. 063206 - PALETTA BASKET GD****€ 17,87 cad**

Sesta paletta allontanamento gara basket
Stampata su entrambi i lati
A norma FiBa
Sfondo rosso e scritta "GD" bianco
Dimensioni paletta cm 32x25
Dimensioni lettere cm 10x20 h

**COD. 063111 - FRECCIA POSSESSO PALLA****€ 13,91 cad**

Freccia direzionale realizzata in PVC.
Lato visivo 20 x 10 cm.
Conforme alle normative FFBB

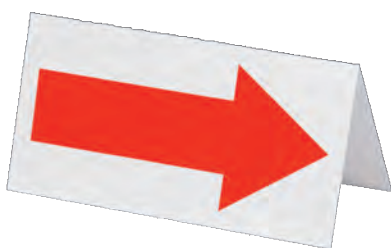
**COD. 100255 - FRECCIA ELETTRONICA POSSESSO****€ 506,85 cad** PALLA

cm 56x23,5x9



**MADE
IN
ITALY**
COD. 572500 - TAVOLO GIUDICI BASKET**€ 1.841,40 cad**

Tavolo per giudici basket
Struttura in tubo di acciaio verniciato
Piano in bilaminato
300x72x76h
acciaio verniciato

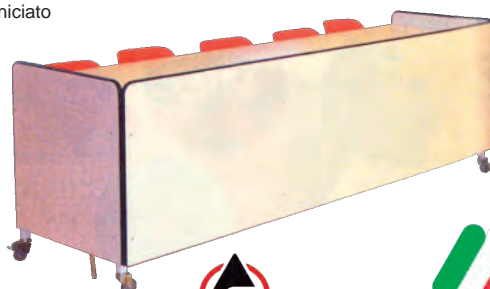

**MADE
IN
ITALY**

104 - handball

COD. 007800 - PORTE HANDBALL 3x2 ACCIAIO

€ 1.643,00 coppia

In acciaio verniciato bianco/rosso tubo quadro
Smontabili e trasportabili
cm 300x200
Sostegni posteriori
Alto cm 80 - basso cm 100
Trasportabili
Reti escluse



COD. 007801 - PORTE HANDBALL 3x2 ALLUMINIO

€ 2.108,00 coppia

In alluminio verniciato bianco/rosso tubo quadro
Smontabili e trasportabili
cm 300x200
Sostegni posteriori
Alto cm 80 - basso cm 100
Trasportabili
lega
Reti escluse



COD. 000159 - RETE CALCETTO-HANDBALL QUADRA

€ 129,20 coppia

Maglia quadra
annodata
mm 100
cm 300x200
Pe

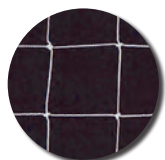

Ø 3,5 mm

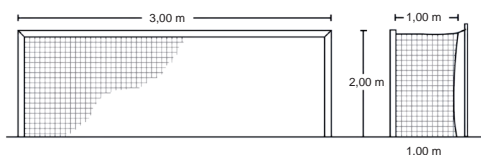

COD. 063221 - KIT 3 CARTELLINI HANDBALL

€ 14,06 kit

TEMPO MORTO

Set di 3 cartellini verdi per time-out di handball
Numerati T1, T2 e T3
Flessibili e resistenti
Dimensioni: 15x20 cm
PP



COD. 064240 - PORTA HANDBALL FLEXIGOAL 240x170

€ 251,60 cad

Porta da handball utilizzabile su tutti i tipi di terreno
Si monta e smonta in pochi minuti
Con cuscinetti antiscivolo sotto la base della porta
Borsa per il trasporto inclusa
Struttura in acciaio leggera e resistente
Mt 2,40x1,70



COD. 064246 - PORTA HANDBALL PVC 240x170

€ 284,10 cad

Porta da handball utilizzabile sia all'esterno che all'interno
Facile da montare e piegare
Tubo ø 70 mm
Rete in PE ritorta da 2,5 mm con maglia 50 mm inclusa
Picchetti a U inclusi
Mt 2,40x1,70



COD. 241920 - BASTONE HOCKEY**€ 15,50 cad**

Bastone hockey floorball per educazione fisica, lunghezza 85 cm, PVC

**COD. 89005U - DISCO STREET HOCKEY****€ 9,18 cad**Dischi da hockey su strada ø 75 mm
Vinile**COD. 063499 - SAGOMA GONFIABILE HANDBALL****€ 125,80 cad**Sagoma gonfiabile ideale per allenamento di basket e handball
Base riempibile con acqua per una maggiore stabilità e utilizzo sicuro
Facile da spostare grazie alle maniglie laterali
Torna sempre nella posizione verticale inizialmente autonomamente
Larghezza 60 cm
Altezza 2,4 mt
Pvc**COD. 089051 - KIT HOCKEY****€ 198,12 kit**

Kit composto da 12 bastoni hockey floorball in 2 colori + 12 palline forate, per educazione fisica, lunghezza 85 cm, PVC

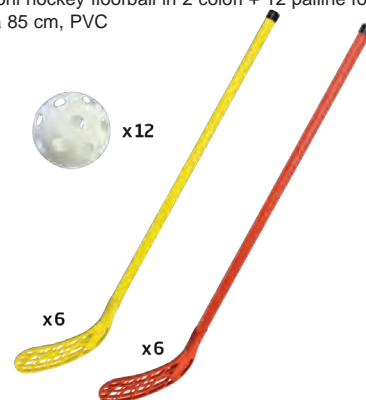
**COD. 89035U - PALLINA UNIHOCKEY****€ 2,39 cad**

Pallina forata in PVC, ø 7 cm

**COD. 210801 - PORTICINA UNIHOCKEY****€ 288,42 cad**Smontabile
Profilo a sezione tonda mm 30
In acciaio verniciato
Rete inclusa
Cm 160x115 h

**MADE
IN
ITALY**

106 - rugby

COD. 67314C - PALLONE RUGBY 5

€ 17,78 cad

Pallone ideato per l'introduzione alla pratica del rugby
Con tasselli per un'ottima presa
Cucito a mano



COD. 67314B - PALLONE RUGBY 4

€ 17,78 cad

Pallone ideato per l'introduzione alla pratica del rugby
Con tasselli per un'ottima presa
Cucito a mano



COD. 67314A - PALLONE RUGBY 3

€ 17,78 cad

Pallone ideato per l'introduzione alla pratica del rugby
Con tasselli per un'ottima presa
Cucito a mano



COD. 067304 - PALLONE RUGBY SPUGNA

€ 12,54 cad

Pallone da rugby in schiuma di poliuretano grezzo
Pallone molto leggero, utilizzato per tutti i tipi di giochi indoor, poiché ha un rimbalzo basso. Ideale per scoprire il rugby indoor
Ø15 cm
Peso: 165 g
Lunghezza 24 cm



COD. 250009 - PALLONE RUGBY U70

€ 25,50 cad

Pallone propedeutico per il rugby
In gomma doppio strato anti trauma
Utilizzabile sia in palestra che all'aperto
Dimensioni: cm 19/28
Peso: 450 gr



COD. 223400 - PALLONE MINIRUGBY V71

€ 20,06 cad

Pallone da minirugby realizzato in gomma monostrato
Non tossico
Dimensioni: cm 15/27
Peso: 350 gr



COD. 060096 - SUPPORTO PER PALLONE RUGBY

€ 8,46 cad

Supporto in pvc per pallone da rugby



COD. 078024 - BORSA PORTA 6 PALLONI RUGBY

€ 17,33 cad

Borsa porta pallone da rugby in resistente tela di nylon
Può contenere fino a 6 palloni misura 5
Facile da chiudere grazie al velcro nella clip
Dotata di tracolla per un facile trasporto
Colore nero
Dimensioni: 115x32 cm



COD. 063248 - CINTURA FLAG RUGBY

€ 4,29 cad

Ideale per l'iniziazione al rugby grazie alle 2 cinghie in velcro che permettono di simulare i placcaggi
Cintura regolabile con clip per un maggiore comfort
Disponibile in 4 colori: rosso, giallo, verde e blu
Flag: 41 cm
Circonferenza vita: 130 cm

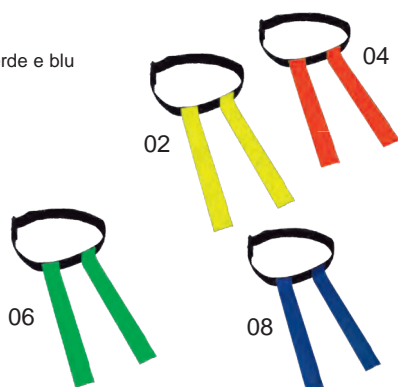

COD. 325700 - PROTEZIONE QUADRA PER PORTA RUGBY

€ 776,90 cad

Chiusura con velcro
Cm 40x40x250 H
Foro 12 cm
Colore Rosso o Royal



COD. 063310 - CASACCA RUGBY REVERSIBILE

€ 16,15 cad

Tessuto liscio
Resistente ed elastico
Cuciture rinforzate
Confezione singola
XS/S: cm
M/L: cm 61x75h
XL/2XL: cm 64x82h



COD. 325600 - PROTEZIONE TONDA PER PORTA RUGBY

€ 544,00 cad

Chiusura con velcro
Spessore 20 cm
H 250 cm
Foro 12 cm
Circolare
Colore Rosso o Royal



COD. 063498 - SAGOMA GONFIABILE RUGBY H 125

€ 77,90 cad

Sagoma gonfiabile ideale per i bambini che iniziato ad approcciarsi al rugby
Progettata appositamente per il placcaggio all'altezza della vita in totale sicurezza
Base riempibile con acqua per una maggiore stabilità e utilizzo sicuro
Facile da spostare grazie alle maniglie laterali
Torna sempre nella posizione verticale iniziale autonomamente
Larghezza 35 cm
Altezza 1,25 mt
Pvc



COD. V00034 - PARADENTI FOX40

€ 3,60 cad

Misura unica



COD. 012566 - SOSPENSORIO CON CONCHIGLIA

€ 22,95 cad

Conchiglia estraibile
35% pes
29% co
17% helanca
10% viscosa
9% elastico



108 - ritmica

COD. 100101 - PALLA RITMICA GS42

€ 16,66 cad

Con valvola rigonfiabile
Indicata nell'esercizio terapeutico e rieducativo
Ø 19 cm
gr 420
Gomma sintetica

 MADE
IN
ITALY



COD. 100102 - PALLA RITMICA GS40

€ 13,26 cad

Con valvola rigonfiabile
Ideale per l'avviamento alla pratica sportiva
Ø 15,5 cm
gr 250
Gomma sintetica

 MADE
IN
ITALY



COD. 100103 - PALLA RITMICA GARA 100

€ 37,20 cad

Con valvola rigonfiabile
Palla ritmica per competizioni ufficiali
Approvata FIG
Ø 18,2 cm
gr 400
Silicone

 MADE
IN
ITALY



COD. 033122 - CLAVETTE IN NYLON CM 45

€ 15,73 paio

Coppia di clavette in plastica
Ideali per l'allenamento
Cm 45
Peso 160 gr



COD. 033120 - CLAVETTE IN NYLON CM 34

€ 10,94 paio

Coppia di clavette in plastica
Ideali per l'allenamento
Cm 34
Peso 90 gr



COD. 044092 - CORDA RITMICA

€ 4,96 cad

Mt 3
Pp

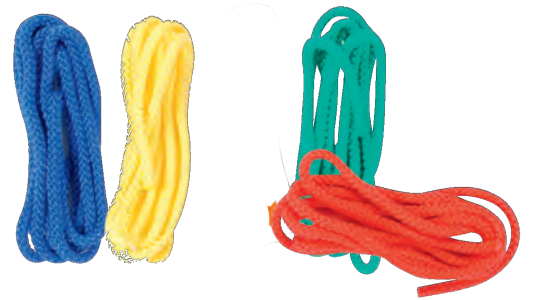

COD. 102010 - BASTONE LEGNO CM 100

€ 5,44 cad

cm 100 Ø 24
legno verniciato



CERCHIO TUBOLARE

- COD. 63028A** - ø 65 € 7,35 cad
- COD. 63028C** - ø 75 € 8,80 cad
- COD. 63028D** - ø 85 € 9,75 cad

A sezione rotonda
Pe

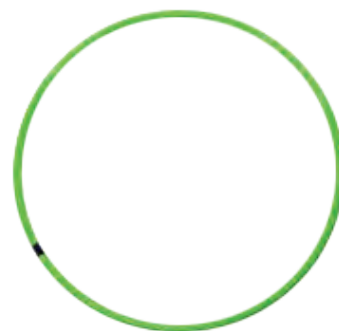
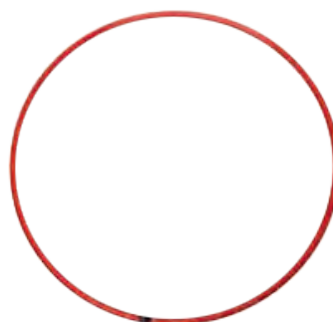

COD. 033140 - NASTRO RITMICA 4 MT

€ 17,68 cad

Con astina
Colori assortiti
mt 4

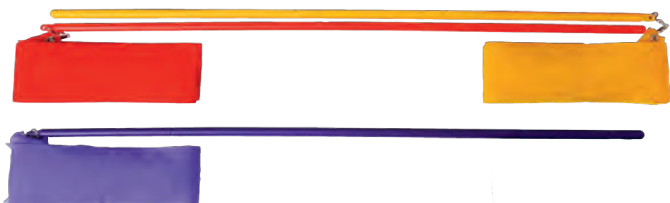

COD. 099001 - NASTRO RITMICA 6 MT

€ 11,21 cad

Con astina
Colore rosa
mt 6

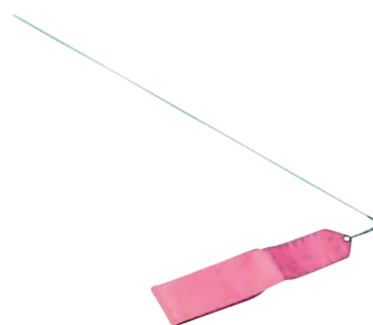

MATERASSO GYM

- COD. 100873** - 200x100x3 h € 206,96 cad
- COD. 100874** - 200x100x4 h € 253,67 cad
- COD. 100875** - 200x100x5 h € 353,84 cad
- COD. 100876** - 200x100x6 h € 400,42 cad

Materasso cellula chiusa



110 - atletica

COD. 180601 - OSTACOLO ATLETICA H 50-76

€ 118,69 cad

Ostacolo regolabile in 3 altezze
h 50/60/76
Acciaio zincato
Con assicella in legno



COD. 025004 - KIT 6 TESTIMONI PLASTICA

€ 18,90 kit

Adatti per l'allenamento e la competizione
6 colori diversi
CM 30
Ø 38 mm

PVC



COD. 180602 - OSTACOLO ATLETICA H 76-106

€ 122,88 cad

Ostacolo regolabile in 4 altezze
h 76/84/91/106
Con assicella in legno



COD. AB0010 - KIT 6 TESTIMONI ALLUMINIO

€ 53,64 kit

Adatti per l'allenamento e la competizione
6 colori diversi
Certificato IAAF
Ø 38 mm
Alluminio anodizzato



COD. 000202 - OSTACOLO REGOLABILE FERRO

€ 49,37 cad 60/70/80/90

Ostacolo in ferro verniciato regolabile in altezza da 60 a 90 cm, larghezza cm 100



COD. 025007 - BLOCCO PARTENZA CLUB

€ 142,80 cad

Blocco di partenza regolabile in acciaio
Rivestimento antiscivolo
Fornito con punti di fissaggio a pavimento

Lunghezza: 81 cm

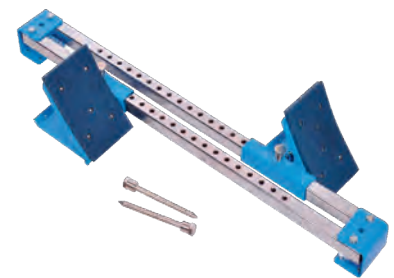

COD. 025006 - BLOCCO PARTENZA ALLENAMENTO

€ 82,28 cad

Blocco di partenza regolabile in acciaio
Rivestimento antiscivolo
Fornito con punti di fissaggio a pavimento

Lunghezza 61 cm



COD. 062745 - ROTELLA METRICA MT 20

€ 18,89 cad

Rotella metrica metri 20
In fibra di vetro
PVC



COD. 181000 - ASTICELLA SOFT SALTO IN ALTO

€ 61,20 cad

Asticella segnalimite in polietilene espanso
Composta da 12 cilindri di lunghezza cm 33 ø 3
Collegati da un elastico con alle estremità
Farfalle per il bloccaggio

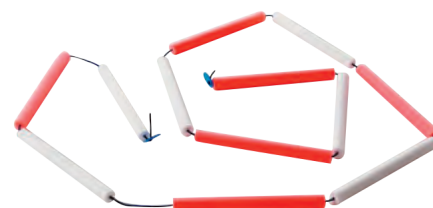

COD. 024051 - ROTELLA METRICA MT 30

€ 24,00 cad

Rotella metrica metri 30 con impugnatura
In fibra di vetro
PVC



COD. 031501 - NASTRO DELIMITAZIONE PERCORSI

€ 10,71 cad

Per delimitare i percorsi
Mt 200
Pe

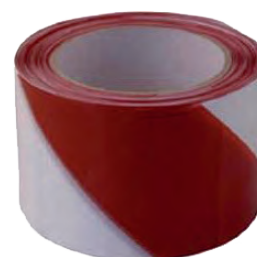

COD. 024052 - ROTELLA METRICA MT 50

€ 33,97 cad

Rotella metrica metri 50 con impugnatura
In fibra di vetro
Pvc



COD. 502126 - MEGAFONO

€ 90,36 cad

Alimentazione a pile



COD. 019758 - CONTAMETRI

€ 115,60 cad

Con luce
Può contare fino a 9999 mt



112 - atletica

PALLA GETTO VDL

- COD. 103125** - ø CM 10 / KG 1 € 36,48 cad
COD. 103126 - ø CM 20 / KG 2 € 58,52 cad
COD. 103127 - ø CM 30 / KG 3 € 78,66 cad
COD. 103128 - ø CM 40 / KG 4 € 111,34 cad

Palla ideale per la propedeutica da utilizzare sia in interno che in esterno
Non tossica e latex-free
Gomma



PALLA LANCIO

- COD. VT0800** - GR 80 € 10,80 cad
COD. VT3000 - GR 300 € 18,00 cad
COD. VT5000 - GR 500 € 23,85 cad
COD. VT7000 - GR 700 € 31,95 cad

Palla in gomma sintetica reticolata propedeutica al lancio del peso
Non rimbalza
Atossica



COD. 181408 - DISCO GOMMA 3 IMPUGNATURE GR 800

€ 40,12 cad

Disco a 3 impugnature per la propedeutica al lancio
Presca 1: avviamento al lancio
Presca 2: allenamento
Presca 3: presa da gara
ø cm 20
gr 800
Gomma



MADE IN ITALY

COD. 181406 - DISCO GOMMA 3 IMPUGNATURE GR 600

€ 39,78 cad

Disco a 3 impugnature per la propedeutica al lancio
Presca 1: avviamento al lancio
Presca 2: allenamento
Presca 3: presa da gara
ø cm 20
gr 600
Gomma



MADE IN ITALY

COD. 181404 - DISCO GOMMA 3 IMPUGNATURE GR 400

€ 34,00 cad

Disco a 3 impugnature per la propedeutica al lancio
Presca 1: avviamento al lancio
Presca 2: allenamento
Presca 3: presa da gara
ø cm 20
gr 400
Gomma



MADE IN ITALY



COD. 113001 - VORTEX

€ 34,00 cad

Per uso scolastico
cm 32
gr 130



COD. 250016 - CHIODO ATLETICA MM 6 A PIRAMIDE

€ 6,15 blister

Blister da 12 pezzi



COD. 099050 - GIAVELLOTTO FOAM CM 90

€ 22,80 cad

Studiato per la propedeutica del lancio
Le alette posteriori assicurano una perfetta stabilità nell'aria e rendono la sua traiettoria perfettamente lineare
Grazie al tipo di materiale, assorbe tutti gli urti delle cadute
cm 90
Gr 110

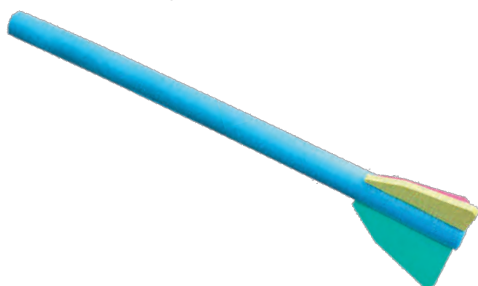

COD. 250017 - CHIODO ATLETICA MM 9 A PIRAMIDE

€ 6,40 blister

Blister da 12 pezzi



COD. 250018 - CHIAVE PER CHIODO ATLETICA

€ 3,54 cad

Confezione da 10 pezzi



114 - atletica

MATERASSI

COD. 200300 - 200x100x20 h	€ 450,50 cad
COD. 200400 - 200x100x30 h	€ 552,50 cad
COD. 200500 - 200x100x40 h	€ 664,70 cad
COD. 200600 - 200x100x50 h	€ 756,50 cad
COD. 200800 - 200x200x40 h	€ 1.261,40 cad
COD. 200900 - 200x200x45 h	€ 1.370,20 cad
COD. 201000 - 200x200x50 h	€ 1.509,60 cad
COD. 201100 - 300x200x30 h	€ 1.574,20 cad
COD. 201200 - 300x200x40 h	€ 1.888,70 cad
COD. 201300 - 300x200x50 h	€ 2.295,00 cad



In gommapiuma rivestito in pvc
Antibatterico, antimuffa, ignifugo cl.2 D/16



**Per materassi e fodere antiscivolo
prezzo a preventivo**

FODERE

COD. 203500 - 200x100x20 h	€ 265,20 cad
COD. 203600 - 200x100x30 h	€ 285,60 cad
COD. 203700 - 200x100x40 h	€ 299,20 cad
COD. 203800 - 200x100x50 h	€ 314,50 cad
COD. 203900 - 200x200x40 h	€ 557,60 cad
COD. 204000 - 200x200x45 h	€ 571,20 cad
COD. 204100 - 200x200x50 h	€ 579,70 cad
COD. 204200 - 300x200x30 h	€ 737,80 cad
COD. 204300 - 300x200x40 h	€ 765,00 cad
COD. 204400 - 300x200x50 h	€ 792,20 cad



MATERASSI

- | | |
|-----------------------------------|----------------|
| COD. 201400 - 400x200x40 h | € 2.636,70 cad |
| COD. 201500 - 400x200x45 h | € 2.864,50 cad |
| COD. 201600 - 400x200x50 h | € 3.060,00 cad |



In gommapiuma rivestito in pvc
 Formato da 2 pezzi unibili fra loro tagliati a 45° da un lato
 Antibatterico, antimuffa, ignifugo cl.2 D/16



FODERE

- | | |
|-----------------------------------|----------------|
| COD. 204500 - 400x200x40 h | € 1.156,00 cad |
| COD. 204600 - 400x200x45 h | € 1.183,20 cad |
| COD. 204700 - 400x200x50 h | € 1.207,00 cad |

**Per materassi e fodere antiscivolo
 prezzo a preventivo**

COD. 128000 - CARRELLO PER TRASPORTO

€ 513,40 cad **MATERASSI**

Carrello per trasporto materassi
 In tubo di acciaio verniciato con ruote gommate
 cm 200x100

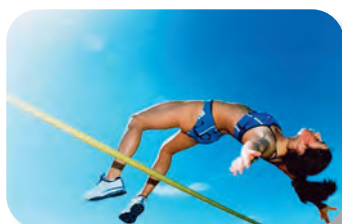

116 - sport con racchetta

COD. 034327 - RACCHETTA BADMINTON SIREN

€ 8,50 cad

cm 66
acciaio - alluminio



COD. 011075 - RACCHETTA BADMINTON EVOLUTION

€ 21,96 cad

grafite - acciaio



COD. 011044 - IMPIANTO BADMINTON PIEGHEVOLE

€ 105,72 cad

Impianto badminton con struttura in tubo d'acciaio da ø 19
Facile da montare e smontare
Borsa per trasporto inclusa
Mt 3x1,5 h



COD. 00P160 - RETE BADMINTON REGOLAMENTARE

€ 58,82 cad

cm 610x60 h
Pe

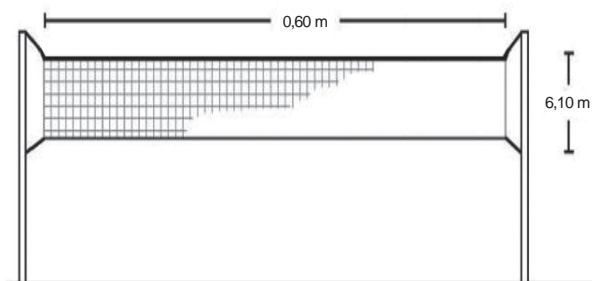

COD. 011077 - KIT 6 VOLANI SCOLAIRES

€ 30,02 kit

Ideale per la scoperta del badminton
Kit 6 pezzi



COD. 011086 - KIT 6 VOLANI ENTRAINEMENT

€ 10,75 kit

Velocità media
Punta in sughero e corpo in nylon
Kit 6 pezzi



COD. 011041 - KIT 6 VOLANI INITIATION

€ 9,96 kit

Velocità adatta ai principianti
Punta in schiuma e corpo in nylon
Kit 6 pz
Nylon



COD. 006780 - IMPIANTO MINIVOLLEY-BADMINTON

€ 680,00 cad

Trasportabile su ruote
Zavorrato



COD. 014053 - KIT 6 PALLINE PING PONG

€ 4,45 kit

Kit composto da 6 palline
 Diametro 40 mm
 Da competizione
 Abs



COD. 014061 - KIT 100 PALLINE PING PONG

€ 55,28 kit

Sacchetto da 100 palline da ping pong del diametro di 40mm
 Facilmente trasportabili
 Materiale ABS



COD. 014044 - SUPPORTO CON PINZA RETE PING PONG

€ 33,21 cad

Kit composto da 2 supporti + 1 rete
 Supporti agganciabili tramite morsetto
 e regolabili
 cm 22x15 h



COD. 0TV015 - RETE TENNIS TAVOLO SUPER

€ 4,37 cad

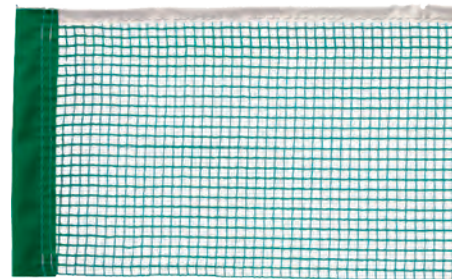

COD. 014058 - RACCHETTA PING PONG HURRICANE

€ 15,73 cad

Racchetta dinamica, ideale per principianti
 Rivestimento con puntini interni e schiuma da 1,8 mm
 Racchetta omologata ITTF
 4 stelle.



COD. 014056 - RACCHETTA PING PONG SHOOTER

€ 7,94 cad

Racchetta per uso scolastico e apprendimento ping pong
 Rivestimento con puntini interni e schiuma da 1,5 mm
 1 lato rosso e 1 lato nero
 2 stelle



COD. 014080 - SEGNAPUNTI PING PONG PIEGHEVOLE

€ 63,38 cad

2 serie di numeri da 0 a 31 e 2 serie di numeri da 0 a 7
 Dimensioni da piegato: 20x38 cm



118 - sport con racchetta

COD. 013019 - RACCHETTA PICKLEBALL PRINCIPIANTI

€ 28,29 cad

Racchetta in fibra di vetro per principianti molto leggera e con un grip eccellente
Adatta anche per i bambini fino a 8 anni
Dotata di tecnologia ultra spin per transizioni dritto/rovescio più fluide
Larghezza 18,2 cm
Altezza 35,5
Spessore 10,5 mm
Peso 175 gr



COD. 013017 - RACCHETTA PICKLEBALL CARBONIO

€ 42,50 cad

Racchetta ad alte prestazioni progettata per offrire la massima potenza
Dotata di tecnologia Ultra Spin per transizioni più fluide tra dritto e rovescio e di tecnologia Buffer per ridurre le vibrazioni
Fibra di carbonio con anima in polipropilene
Larghezza 19 cm
Altezza 41,5 cm
Spessore 16 mm
Peso 205 gr



COD. 013001 - RACCHETTA PICKLEBALL FIBRA DI

€ 35,39 cad VETRO

Racchetta con bordo protettivo per proteggerla da graffi e impatti con il terreno
Manico con impugnatura in PU per garantirne la presa e maggior comfort
Dotata di tecnologia ultra spin che facilita il passaggio da rovescio a dritto
Dotata anche di tecnologia technical buffer che permette di ridurre le vibrazioni per migliorare le prestazioni di gioco
PP rivestito in fibra di vetro



KIT 3 PALLINE PICKLEBALL

COD. 013002 - INDOOR

€ 9,79 kit

COD. 013003 - OUTDOOR

€ 9,79 kit

Kit di 3 palline da ø 74 mm
Con 26 fori la versione indoor
Con 40 fori la versione outdoor
Inclusa retina per il trasporto
PE



COD. 013021 - MARCATORE CAMPO A L

€ 3,99 cad

Marcatore a L per campo pickleball
Dimensioni: 27x27x6 cm



COD. 013020 - MARCATORE CAMPO A T

€ 3,99 cad

Marcatore a T per campo pickleball
Dimensioni: 27x27x6 cm



COD. 069103 - MARCATORE CAMPO A LINEA

€ 3,19 cad

Marcatore antiscivolo in gomma morbida e molto solida
Con un lato ruvido spesso 3 mm
Adatto anche a campi esterni in sintetico
Dimensioni: 35x7,5

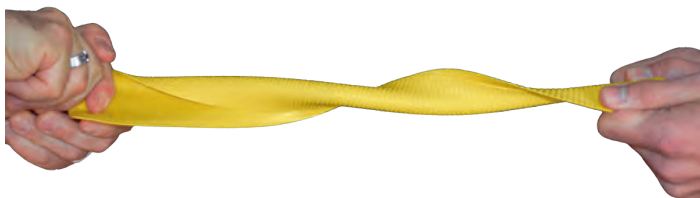

COD. 063192 - LAVAGNA BADMINTON PICKLEBALL

€ 17,71 cad

Lavagna rigida cancellabile con clip in metallo
Un lato raffigura il campo da badminton, l'altro lato un campo da pickleball
Pennarello incluso
Dimensioni: 22,5x36 cm
Pvc

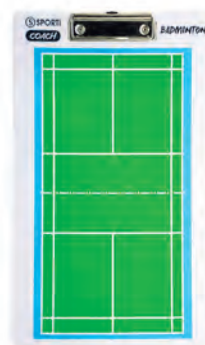

COD. 013007 - RETE PICKLEBALL

€ 238,11 cad

Rete da pickleball progettata per un montaggio rapido, facile e senza attrezzi
Pali in acciaio
Rete in poliestere da 2,2 mm
Maglia da 40 mm
Inclusa borsa per il trasporto
Dimensioni: mt 6,70x91 cm



120 - sport con racchetta

COD. 213900 - PALLINA TAMBURELLO

€ 6,20 cad



COD. 012102 - PALLINA TENNIS GALAXY

€ 7,11 cad

Pallina in PVC dai 4 anni in su
Le sue dimensioni e il suo rimbalzo permettono ai bambini di giocare,
servire e divertirsi
Diametro: 15 cm



COD. 099048 - IMPIANTO CALCIO TENNIS 300x80

€ 91,88 cad

Impianto calcio/tennis con struttura in tubo d'acciaio da \varnothing 19
Facile da montare e smontare
Borsa per trasporto inclusa
Mt 3x0,8 h

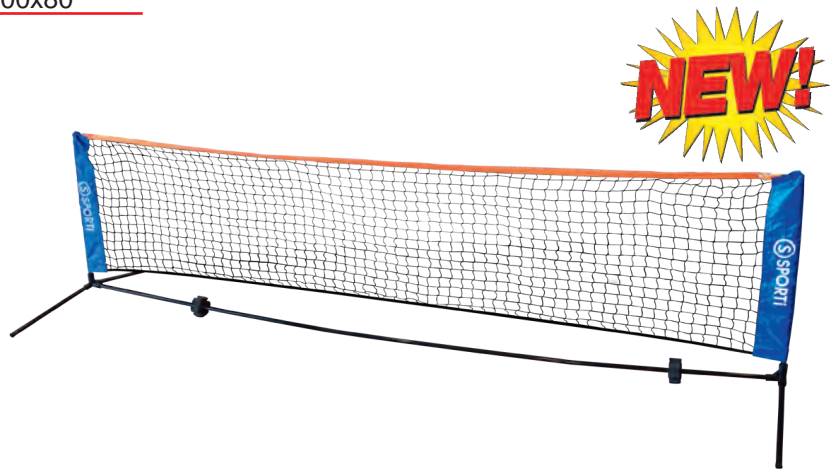

COD. T00100 - NASTRO CENTRORETE TENNIS

€ 22,10 cad

Misura regolamentare con gancio



COD. T02200 - RETE TENNIS ESAGONALE

€ 255,51 cad

Rete esagonale
Maglia mm 45
 \varnothing mm 4
Cavo d'acciaio ricoperto mm 5
mt 12,80x1,07
Pp

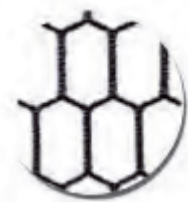

COD. 012070 - KIT 3 PALLINE TENNIS

€ 8,47 kit

Tubo con 3 palline da tennis pressurizzate
Per allenamento



COD. T00300 - NASTRO SEGNACAMPO TENNIS

€ 278,66 cad

mt 150x5 h
Pvc

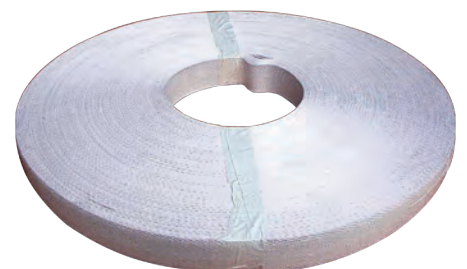

COD. 086021 - KIT 10 LANTERNE ORIENTEERING

€ 52,25 kit

Set di 10 pannelli di plastica rigida 15x15cm
Resistenti all'umidità
Ogni kit è numerato da 1 a 10 con un codice diverso su ogni tessera



COD. 086002 - KIT 5 LANTERNE ORIENTAMENTO

€ 31,62 kit

Indicatore di orientamento in nylon arancione e bianco
Dimensioni: 15 x 15 cm



COD. 086032 - KIT 10 PUNZONI CONTROLLO ORIENTEERING

€ 20,48 kit

Set di 10 pinze con diverse forme di punzoni per marcare durante la competizione e l'allenamento



COD. 086040 - BUSSOLA SCOLASTICA

€ 10,60 cad

Grandi dimensioni dei numeri:
visibilità eccellente
Precisione: 2°
Graduazione: 0-360°
Dimensioni: 90x64x14 mm
Peso: 35 g



COD. 86007B - KIT 50 CARTONCINI ORIENTEERING

€ 12,54 kit

Set di 50 carte di controllo per tutte le gare di orienteering
Dimensioni: 19x9 cm

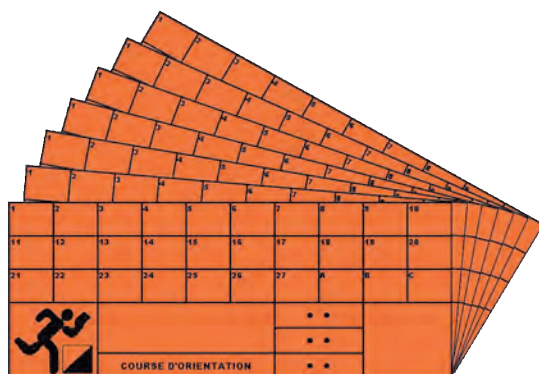

COD. 031501 - NASTRO DELIMITAZIONE PERCORSI

€ 10,71 cad

Per delimitare i percorsi
mt 200
Pe

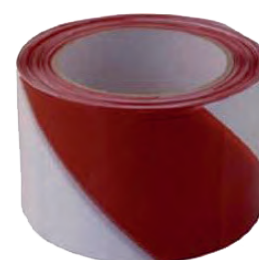

COD. 099231 - KIT 6 BOCCE

€ 20,70 kit

Kit composto da 6 bocce e 1 boccino
Ideale da utilizzare in spiaggia o su prato
Pvc

NEW!



COD. 214100 - MAZZA BASEBALL SOFT

€ 59,50 cad

Cm 71
Gr 460

 **MADE IN ITALY**



COD. 099142 - KIT FLYING BALL

€ 34,96 cad

Set composto da 2 palline e da 1 palla da mm 70
Impugnature in spugna per un maggiore comfort



NEW!

COD. 069215 - VALIGETTA CON ARTICOLI MOTRICITA'

€ 126,92 cad

Kit composto da 4 marcatori tondi, 4 mani, 4 piedi, 4 angoli, 4 frecce e 4 lineari



COD. 099132 - KIT 6 PIETRE EQUILIBRIO SENSORIALI

€ 110,50 kit

Pietre triangolari con diverse pendenze che offrono diversi gradi di difficoltà
Ogni pietra ha la base in gomma antiscivolo per proteggere il pavimento interno
Il set è composto da:
3 pietre grandi lati cm 36x8,5 h
3 pietre piccole lati cm 25x4,5
Carico massimo 75 kg



COD. 099071 - KIT 12 ANELLI DA LANCIO

€ 61,79 kit

Kit di 12 anelli da lancio molto flessibili
Adatti anche ai bambini
Ø cm 18
Gr 200



COD. 099245 - FRISBEE PROFESSIONALE

€ 11,22 cad

Gr 150
ø 24 cm
Pvc

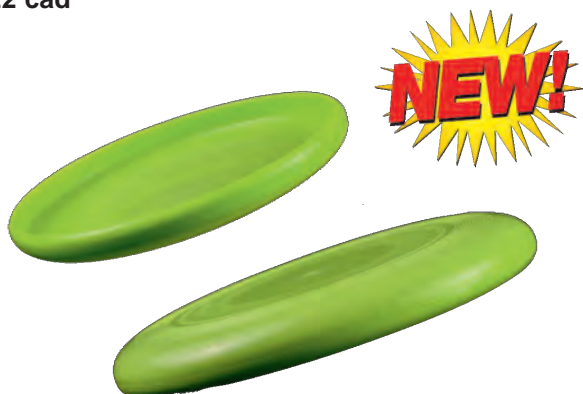

COD. 222000 - PALLA DODGEBALL 2

€ 15,64 cad

Gr 250, ø 20 cm



COD. 099221 - FRISBEE TEMPO LIBERO

€ 4,50 cad

Gr 78
ø 21 cm



COD. 222200 - PALLA OFFBALL

€ 17,00 cad

Gr 250, ø 20 cm



COD. 081016 - BERSAGLIO PER FRISBEE + DISCHI

€ 90,36 cad

Bersaglio regolabile per frisbee, utilizzabile da soli o in coppia per gare di tiro di precisione
H 37 cm
L 77 cm
6 dischi inclusi



COD. 258021 - PALLA OVER MORBIDA

€ 14,18 cad

Palla da gioco molto elastica e morbida
Utilizzabile sia all'aperto che all'interno
Gonfiabile a fiato
E' possibile gonfiarla e sgonfiarla al bisogno
Cannuccia per gonfiaggio inclusa
ø cm 23



COD. 099300 - DADO IN SPUGNA

€ 11,70 cad

Dado in spugna ad alta intensità
Per divertirsi a casa o all'aria aperta
Adatto a tutte le età
Numeri da 1 a 6
Dimensioni: 16x16x16
Gr 155



124 - protezioni

PROTEZIONE CIRCOLARE

COD. 032590 - FORO \varnothing 20	€ 516,80 cad
COD. 032586 - FORO \varnothing 15	€ 391,68 cad
COD. 032582 - FORO \varnothing 10	€ 374,00 cad
COD. MACICA - MISURE A RICHIESTA	€ preventivo



Per esterno
Per ricoprire pilastri tondi o pali luce
Poliuretano espanso ricoperto da telo pvc antitaglio
Chiusura con velcro
Spessore 10 cm
Altezza per tutte le misure 200 cm



PROTEZIONE MURALE

COD. 032526 - 200x200x10 h	€ 551,80 cad
COD. 032525 - 200x150x10 h	€ 491,30 cad
COD. 032524 - 200x100x10 h	€ 333,98 cad
COD. 032522 - 200x100x6 h	€ 271,15 cad
COD. 032541 - 150x100x6 h	€ 234,43 cad
COD. MATTCA - MISURE A RICHIESTA	€ preventivo

Per esterno
Poliuretano espanso ricoperto da telo pvc antitaglio
Con occhielli

Su richiesta applicazione di striscia in velcro per unire più protezioni
(prezzo a preventivo)



Colori disponibili per le protezioni

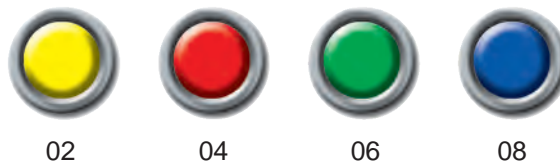

Consegna 30 giorni
Delivery time 30 days



COD. 032593 - PROTEZIONE CIRCOLARE

€ 156,23 cad

Poliuretano espanso ricoperto da telo pvc antitaglio
 Chiusura con velcro
 Foro ø 2 cm
 Spessore 6 cm
 Cm 200 h



PROTEZIONE TUBOLARE PANCHINE

COD. 325150 - CM 200

€ 153,85 cad

COD. 325160 - CM 100

€ 90,95 cad

Protezione tubolare
 Gommapiuma rivestita in PVC
 ø interno cm 5
 Spessore cm 5

Colori rosso, verde, blu



126 - spogliatoio

PANCA SPOGLIATOIO SEMPLICE

COD. 10900E - MT 2

€ 285,20 cad

COD. 109001 - MT 1

€ 195,30 cad

Da fissare a parete
Con soprastante portaborse in legno verniciato



 MADE
IN
ITALY

ATTACCAPANNI

COD. 10908E - MT 2

€ 64,60 cad

COD. 109081 - MT 1

€ 40,80 cad

Da fissare a parete
In legno verniciato



PANCA SPOGLIATOIO CON SCHIENALE

COD. 10901E - MT 2

€ 362,70 cad

COD. 109011 - MT 1

€ 248,00 cad

Tubo di acciaio verniciato a sezione tonda da mm 35
legno verniciato



 MADE
IN
ITALY

ATTACCAPANNI CON PORTABORSE

COD. 10909E - MT 2

€ 221,00 cad

COD. 109091 - MT 1

€ 129,20 cad

Da fissare a parete
Con soprastante portaborse in legno verniciato



PANCA SPOGLIATOIO

COD. 10902E - MT 2

€ 461,90 cad

COD. 109021 - MT 1

€ 322,40 cad

Con schienale e appendiabiti
Tubo di acciaio verniciato a sezione tonda dia mm 35
legno verniciato



 MADE
IN
ITALY

PEDANA POGGIAPIEDI

COD. 10912E - MT 2

€ 166,60 cad

COD. 109121 - MT 1

€ 98,60 cad



PANCA SPOGLIATOIO COMPLETA

COD. 10903E - MT 2

€ 585,90 cad

COD. 109031 - MT 1

€ 409,20 cad

Tubo di acciaio verniciato
a sezione tonda dia mm 35
Sedili schienale
e attaccapanni
Soprastante portaborse
di legno verniciato
legno verniciato

 MADE
IN
ITALY

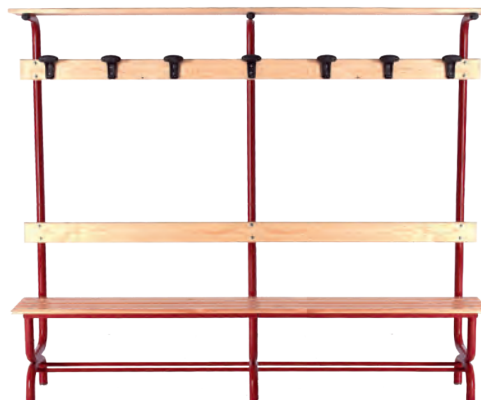

COD. 011943 - ATTACCAPANNI A COLONNA

€ 146,20 cad

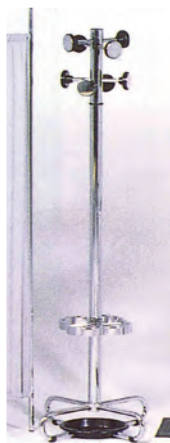

COD. 011935 - LETTINO VISITA MEDICA

€ 1.009,80 cad

Tubo di acciaio cromato
Smontabile
Testiera inclinabile
Piano imbottito e rivestito in sky
cm 185x56x75 h



COD. 180499 - LETTINO MASSAGGI TRASPORTABILE

€ 324,54 cad

Lettino portatile per massaggi
Lunghezza 195 cm o 225 cm
con poggiatesta
Altezza regolabile da 61 a 80 cm
Larghezza 70 cm o 92 cm
con braccioli
Peso massimo portata 300 kg
Imbottitura in schiuma espansa
Con borsa per il trasporto
alluminio



COD. 407564 - ROTOLO CARTA COPRILETTINO

€ 18,03 cad

Rotoli di carta "doppio velo"
di ottima qualità
Resistente e con facilità
di strappo
Da utilizzarsi come
lenzuolino per lettino
cm 60x80 mt
pura cellulosa



COD. 161240 - POGGIAPIEDI TAPPETINO SACCA

€ 10,61 cad

Trasformabile in sacca per indumenti umidi
Dimensioni da chiuso: 16x11x3 h
Ø 65 cm
PI



COD. 458590 - POGGIAPIEDI FOOTSY

€ 15,66 cad

Idrorepellente
Confezione da 10 pezzi, 2 per colore
cm 33x41x1,5



COD. 000099 - PAVIMENTAZIONE ACQUAFLOOR

€ 85,22 mq

Pavimentazione componibile
antiscivolo in morbido pvc
1 mq = 9 pezzi
Trattamento antifungo e antibatterico
Spessore mm 12
Per piscine e spogliatoi
cm 32,5x32,5
Pvc

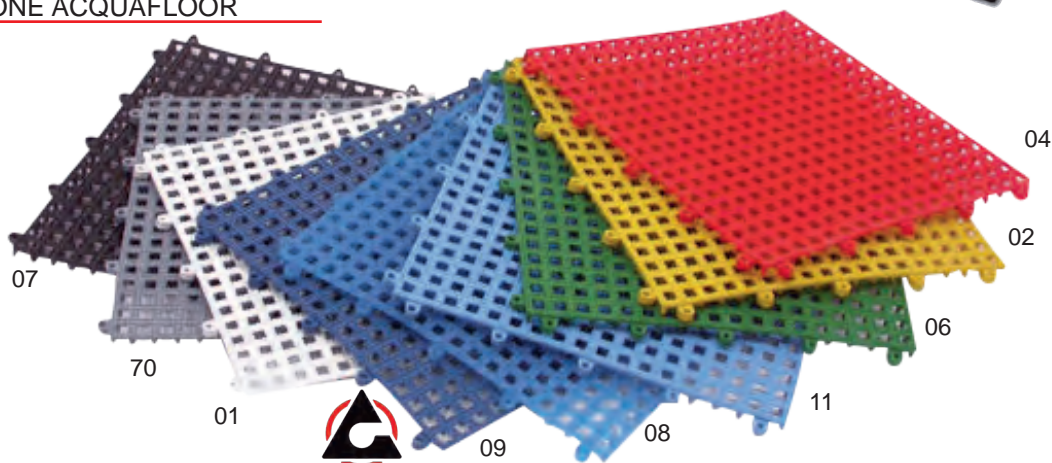

128 - contenitori

COD. 00403G - CONTENITORE CHIUSO GRANDE

€ 468,96 cad

Contenitore in ferro verniciato, completo di lucchetto, capienza 34/36 palloni, adatto per la raccolta di accessori allenamento (ostacoli, cerchi, cono, etc), ruote incluse, cm 100x75x90 h



COD. 000402 - CONTENITORE APERTO ZINCATO

€ 205,53 cad

Contenitore in ferro zincato con sacca in nylon pesante, pieghevole, sfoderabile, cm 60x60x90 h



COD. 000405 - CONTENITORE CHIUSO MEDIO

€ 383,66 cad

Contenitore in ferro verniciato, completo di lucchetto, contiene 24/26 palloni, ruote incluse, cm 75x70x90 h



COD. 900800 - CONTENITORE APERTO ALLUMINIO

€ 99,60 cad

Contiene 18/20 palloni
Cm 102x42x27



COD. 119002 - CONTENITORE CHIUSO PIEGHEVOLE

€ 193,80 cad

Contenitore in ferro zincato, contiene 16/18 palloni, consigliato per le piscine, ruote incluse, cm 80x50x70 h



COD. 200406 - CONTENITORE PORTA ATTREZZI

€ 1.686,06 cad

Contenitore in acciaio zincato, ripiani regolabili in altezza, ruote girevoli di cui 2 con freno, completo di lucchetto, cm 156x76x163 h



COD. 21403Z - CONTENITORE CHIUSO ZINCATO

€ 514,45 cad

Contenitore in acciaio zincato tropicalizzato, completo di lucchetto, contiene 35/40 palloni, consigliato per le piscine, ruote comprese, cm 100x75x90 h



COD. 120006 - TRIBUNA TRASPORTABILE CON SEDUTE**€ 2.746,60 cad**

Panchetta su 3 file trasportabile su ruote
 Struttura in acciaio zincato
 Sedute in pvc
 Piani di calpestio in carply

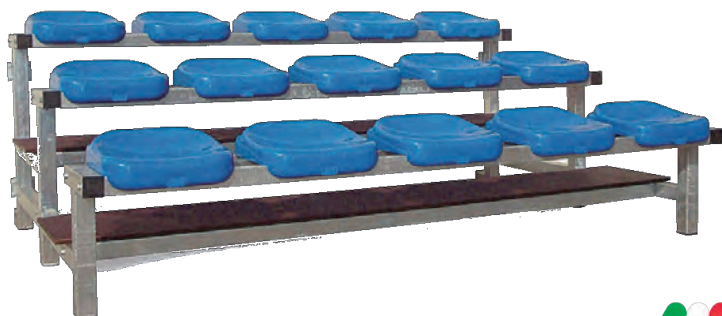
**COD. 120005 - TRIBUNA TRASPORTABILE PANCA****€ 2.442,80 cad**

Panchetta su 3 file trasportabile su ruote
 Struttura in acciaio zincato
 Piani di seduta e calpestio in carply
 Colore bianco



MADE
IN
ITALY

**COD. M90000 - SEDUTA****€ 29,58 cad**

Seduta ignifuga
 Anti uv
 Pp

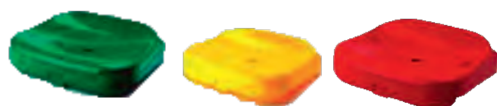

MADE
IN
ITALY

COD. M20100 - SEDUTA CON SCHIENALE**€ 43,18 cad**

Seduta ignifuga
 Anti uv
 Pp

**COD. 390020 - TASSELLO PER FISSAGGIO****€ 2,70 cad**

Tassello per fissaggio al cemento



COD. 172702 - NASTRO TAPE STRAPPAL 2,5x14

€ 6,79 cad

Benda anelastica adesiva
Caratteristica spalmatura a strisce per tutta la lunghezza del bendaggio così da resistere a forti sollecitazioni
Traspirante
Tagliabile a mano senza sfilacciarsi
Indicata per bendaggi preventivi

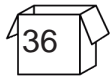

NASTRO TAPE

COD. 550349 - 3,8x10

COD. 550356 - 5x10

COD. 551025 - 5x20

€ 4,36 cad

€ 5,84 cad

€ 11,16 cad



COD. 172704 - NASTRO TAPE STRAPPAL 4x14

€ 10,85 cad

Benda anelastica adesiva
Caratteristica spalmatura a strisce per tutta la lunghezza del bendaggio così da resistere a forti sollecitazioni
Traspirante
Tagliabile a mano senza sfilacciarsi
Indicata per bendaggi preventivi



BENDA COESIVA SELF-FIX

COD. 163426 - 10x4

COD. 163419 - 8x4

COD. 163402 - 6x4

€ 6,38 cad

€ 5,59 cad

€ 4,67 cad

Benda di fissaggio elastica coesiva
Aderisce su se stessa e non sulla pelle, anallergica, permeabile all'aria
Assolutamente antiscivolo
Porosa ed assorbente, si adatta perfettamente ai contorni



COD. 172705 - NASTRO TAPE STRAPPAL 5x14

€ 14,20 cad

Benda anelastica adesiva priva di lattice naturale
Caratteristica spalmatura a strisce per tutta la lunghezza del bendaggio così da resistere a forti sollecitazioni
Traspirante
Tagliabile a mano senza sfilacciarsi
Indicata per bendaggi preventivi



COD. 161088 - BENDA COESIVA PLUS

€ 4,25 cad

Benda elastica cm 6x2,5 mt



COD. 221048 - SALVAPELLE NEW

€ 3,00 cad

Benda salvapelle cm 7x27 mt



COD. 550912 - SALVAPELLE 7x27

€ 4,67 cad

Salvapelle cm 7x27 mt
In schiuma poliuretanic
Autoaderente
Protegge la pelle dalla pressione che deriva dai sistemi di immobilizzazione e la peluria dall'adesivo del bendaggio



TENSOPLAST

- COD. 715470 - 10x4,5** € 22,26 cad
- COD. 715460 - 7,5x4,5** € 15,22 cad
- COD. 715450 - 5x4,5** € 12,65 cad

Benda elastica adesiva porosa ad alta traspirabilità
Indicata nel trattamento di patologie muscolari, tendinee ed articolari
Cotone e viscosa



COD. 341980 - VALIGETTA PRONTO SOCCORSO

€ 199,72 cad

Kit pronto soccorso in valigetta grande
Kg 6,2
Dimensioni: 40x27x13 cm



- Il kit include:
- 2 Flacons soluzione antisettica 500 ml
 - 5 Paia di guanti protettivi sterili
 - 2 Confezioni 10 cerotti assortiti
 - 2 Rotolo cerotto adesivo 2.5 cm x 5 m
 - 1 Garza a rete tubolare
 - 10 Confezioni compresse sterili 10 x 10 cm
 - 2 Confezioni compresse sterili 18 x 40 cm
 - 1 Confezione cotone idrofilo
 - 1 Mascherina con visiera di protezione
 - 1 Paio di forbici da 14.5 cm
 - 2 Pinze sterili
 - 3 Lacci emostatici
 - 1 Sfigmomanometro + stetoscopio
 - 2 Coperta sterile 40 x 60 cm
 - 2 Confezioni ghiaccio istantaneo monouso
 - 1 Termometro digitale
 - 2 Sacchi immondizia
 - 3 Soluzione irrigazione 500 ml



COD. MB010 - BORSA MEDICA PROFESSIONALE

€ 22,00 cad

Con tasche interne per l'inserimento di prodotti medicali
Capienza totale 25 litri
Tracolla regolabile
Poly 600 D



COD. MB004 - BORSA MEDICA FIRST AID

€ 10,40 cad

Capienza totale 10 litri
Tracolla imbottita
Poly 600 D



COD. 170800 - KIT PRODOTTI MEDICALI

€ 39,00 kit

- 5 buste ghiaccio
- 1 ghiaccio spray
- 1 acqua ossigenata
- 1 cerotti classici
- 1 cerotto striscia
- 1 cotone idrofilo
- 1 compresse di garza
- 1 bende idrofile
- 1 benda coesiva visiohaft 8x4



COD. 140038 - COMPRESSE DI GARZA

€ 3,50 cad

Un blister contiene 100 garze cm 10x10

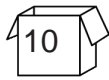

COD. 150020 - BENDE IDROFILE

€ 3,84 cad

3 benze in ogni blister
cm 7x3 mt

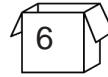

COD. 347150 - BENDA OSSIDO DI ZINCO

€ 15,47 cad

Pronta all'uso

L'alta percentuale di ossido di zinco sospesa in una soluzione di idrocolloide di origine vegetale ne fanno un prodotto ideale e sicuro che si caratterizza per la totale assenza di gelatine e derivanti animali.

Questo fa sì che la benda, anche se conservata in luoghi caldi, mantenga tutte le sue proprietà senza perdere liquidi.

Indicata per distorsioni, lussazioni e fratture
cm 10x7 mt



COD. 150099 - BENDA ELASTICA CON FERMAGLI

€ 2,95 cad

Fasciatura elastica + 2 fermagli
cm 8x5 mt

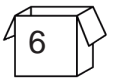

COD. 034130 - FORBICE ACCIAIO RICURVA

€ 15,75 cad

Da utilizzare per taglio bendaggi

Punta arrotondata

Professionale

In acciaio inossidabile

cm 18



COD. 135002 - TAMPONE NASALE EMOSTATICO

€ 23,72 conf

Per fermare il sanguinamento del naso

Deve essere introdotto molto lentamente

Riduce la pressione del sangue e ne blocca la fuoriuscita

In cellulosa naturale

Confezione da 4 tamponi



COD. 020581 - FORBICE MANICO PLASTICA

€ 8,40 cad

Forbice ricurva con impugnatura in plastica

La forma ricurva facilita il taglio dei tessuti

Acciaio inossidabile, manico in plastica

Cm 19



COD. 170011 - ACQUA OSSIGENATA

€ 1,92 cad

Disinfettante contro batteri
Flacone da 250 ml

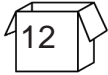

COD. 172100 - COTONE IDROFILO

€ 3,08 cad

Cotone specifico per uso sanitario
Trattato senza candeggianti e privo di fibre sintetiche
gr 90



KINETIC

- COD. BK164546 - PELLE** € 13,86 cad
- COD. BK164539 - BLACK** € 13,86 cad
- COD. BK164515 - ROYAL** € 13,86 cad
- COD. BK164522 - FUXIA** € 13,86 cad

Benda di fissaggio elastica coesiva
Aderisce su se stessa e non sulla pelle, anallergica, permeabile all'aria
Assolutamente antiscivolo
Porosa ed assorbente, si adatta perfettamente ai contorni

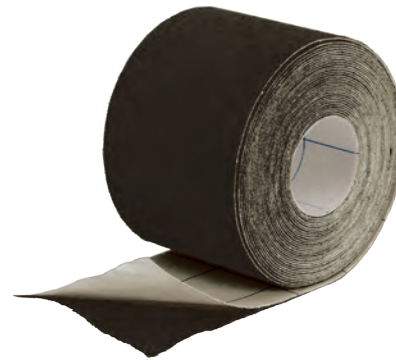
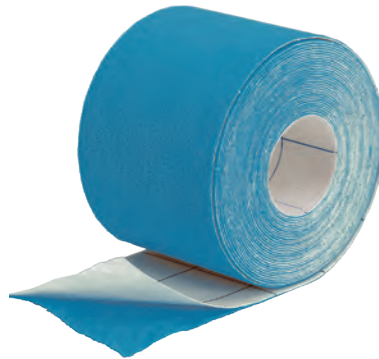

La tecnica ha quattro principali effetti fisiologici:

Corregge la funzione muscolare

Kinetic Tape è efficace nel ripristinare la giusta tensione muscolare: facilita o inibisce la contrazione muscolare (dipende dalla tecnica utilizzata).

Aumenta la circolazione del sangue/linfa

Kinetic Tape aiuta ad eliminare l'eccesso di edema e/o emorragia tra la pelle ed il muscolo.

Riduce il dolore

La soppressione neurologica del dolore avviene dall'applicazione del Kinetic Tape sulla zona colpita, e come menzionato nell'Effetto 2 (vedi sopra).

Assiste nella correzione di allineamento dell'articolazione

La dislocazione di un'articolazione, dovuta alla tensione muscolare anormale, può essere corretta dal Kinetic Tape tramite il recupero della funzione e della fascia muscolare.



COD. 160920 - GHIACCIO BUSTA Istantaneo

€ 1,28 cad

Monouso



COD. 163297 - GHIACCIO SPRAY

€ 5,90 cad

Con erogatore professionale
ml 300



COD. 163983 - GEL CALDO FREDDO + FASCIA

€ 7,65 cad

Impacco caldo/freddo riutilizzabile
Soffice e malleabile gelatina contenuta in un sacchetto di plastica a doppio strato
Indicato per il pronto soccorso in caso di contusioni, strappi e traumi in genere



COD. 163358 - BORSA GHIACCIO

€ 16,74 cad

Bocca larga
cm 23



COD. 066006 - GHIACCIAIA CON RUOTE

€ 247,85 cad

Ghiacciaia con manico telescopico e ruote per facilitare il trasporto
Ideale per mantenere fresche le bevande o i sistemi di crioterapia
Coperchio con 4 fessure per le tazze
Tappo di scarico sul retro per svuotare il ghiaccio sciolto
Dimensioni: 49x44x52 h
Peso 6,5 kg
Capacità 55 litri



COD. 112910 - GHIACCIAIA GRANDE

€ 103,85 cad

Pratico contenitore per ghiacci riutilizzabili
Capacità 15 lt
cm 38x26x37 h



COD. 162511 - CEROTTO STERILE

€ 4,67 cad

Nastro sterile per suture cutanee
In tessuto non tessuto rinforzato
cm 6x75 mm



COD. 170933 - INTEGRATORE BUSTA 330 GR

€ 9,77 cad

Integratore di sali minerali e vitamina C
E' un prodotto per sportivi destinato a reintegrare le perdite idrosaline dovute a
profusa sudorazione
Sciogliere il contenuto della busta in 5/6 litri d'acqua
Gusto limone
gr 330



COD. 130312 - CEROTTO IDROCOLLOIDALE VESCICHE

€ 3,43 cad

Cerotto idrocolloidale per la prevenzione e il trattamento delle vesciche
Confezione da 5 cerotti
cm 3,8x7

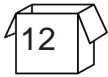

COD. 182700 - INTEGRATORE

€ 0,82 cad

Sciogliere il contenuto della busta in 150 ml d'acqua
gr 10



COD. 110123 - CEROTTO IN STRISCIA

€ 2,45 cad

cm 6x1 mt

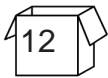

COD. 150500 - DISPENSER MEGA MJ 500

€ 24,13 cad

Capacità 5 litri



COD. 110024 - CEROTTI CLASSICI

€ 1,61 cad

Strato di pura garza antiaderente
Blister da 20 cerotti
cm 7x2

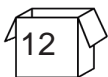

COD. 160006 - CREMA ARNICA

€ 26,04 cad

Prodotto indicato per il trattamento rilassante della muscolatura e lenitivo articolare
A base di arnica ad azione calmante
Ottimo dopo attività sportiva
ml 250



COD. 191030 - OLIO PRESPOST RISCALDANTE

€ 15,54 cad

Ideale per la preparazione all'attività sportiva
ml 300



COD. 171225 - PASTA SPASPASTE

€ 24,18 cad

Pasta cremosa a base di fango marino ed essenze naturali
Riassorbente, rinfrescante e rafforzante
Si spalma per uno strato di circa 2mm sulla parte interessata e mantenuta per circa 6/8 ore
Si ottiene una migliore efficacia dei principi attivi usando un bendaggio non occlusivo
ml 250



COD. 230300 - OLIO NEUTRO BASE 500 ML

€ 18,45 cad

Olio da massaggio neutro
Indicato per trattamenti cosmetici e articolari



COD. 171325 - GEL TRAUMAGEL

€ 28,64 cad

Antidolorifico - Gel riattivante della circolazione a base di estratti naturali
Ottimo defaticante muscolare
Unito a SPASPASTE è particolarmente efficace per il riassorbimento rapido di ematomi e gonfiori causati da distorsioni e/o lesioni muscolari
ml 250



COD. 171000 - SPRAY DEPILATORIO

€ 17,69 cad

Schiuma depilatoria
Ideale per utilizzo sportivo grazie alla sua azione rapida
Idrosolubile, emolliente e non testata su animali
200 ml



COD. 214300 - CREMA CONDUTTIVA TECAR

€ 44,64 cad

Crema ad uso professionale per trattamenti elettromedicali
Conduttrice per trattamento capacitivo e resistivo
Ottima anche per il massaggio manuale



COD. 191325 - CREMA SOPRASSELLA

€ 20,21 cad

Crema antisfregamento per proteggere la pelle del soprasella durante il ciclismo
Grantisce una maggiore scorrevolezza e una costante sensazione di sollievo e freschezza sulla pelle
Funzione preventiva, lenitiva e anti-arrossamento



COD. 034107 - BARELLA PIEGHEVOLE

€ 282,15 cad

Portata massima 170 kg
cm 201x48x14



COD. 780053 - SCALDAMANI HAND WARMER

€ 2,77 cad

Scaldamani ideale per tenere al caldo le mani
Il caldo si attiva a contatto con l'aria ed ha una durata di 9 ore
Temperatura tra 36° e 43°

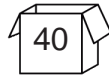

COD. 780046 - SCALDAPIEDI TOE WARMER

€ 2,77 cad

Scaldadita ideale per tenere al caldo i piedi
Il caldo si attiva a contatto con l'aria ed ha una durata di 9 ore
Temperatura tra 36° e 43°



COD. 780039 - SOLETTA PIEDI FOOT WARMER

€ 5,43 cad

Soletta ideale per tenere al caldo i piedi
Il caldo si attiva a contatto con l'aria
Ha una durata di 8 ore
Temperatura tra 35° e 39°
Taglia unica

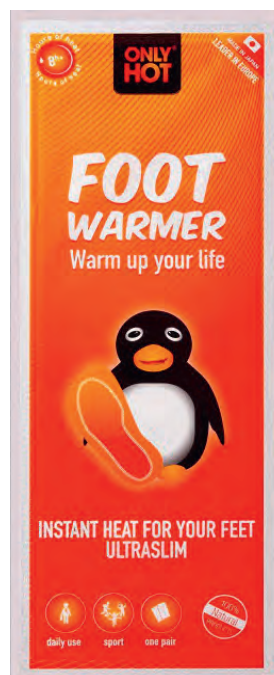

138 - numeri

COD. 100012 - NUMERO CLASSIC SFUSO CM 23

€ 1,22 cad

Numero serigrafico



1 2 3 4 5
6 7 8 9 0

White
Bianco

1 2 3 4 5
6 7 8 9 0

Black
Nero



1 2 3 4 5
6 7 8 9 0

Navy
Blu

1 2 3 4 5
6 7 8 9 0

Royal blue
Royal



	01	bianco	white
	02	giallo	yellow
	03	arancio	orange
	04	rosso	red
	05	granata	burgundy
	06	verde	green
	07	nero	black
	08	royal	royal
	09	blu	navy
	10	viola	violet
	11	celeste	sky blue
	20	giallo fluo	yellow fluo
	22	oro	gold
	30	arancio fluo	orange fluo
	60	verde fluo	green fluo
	70	grigio	grey
	40	fucsia	fuxia
	400	rosa	pink
	998	trasparente	transparent

Listino

Il presente listino su catalogo annulla e sostituisce ogni precedente ed è in vigore dal **01 Giugno 2026**. Nessuna Ns. responsabilità per eventuali errori tipografici dovuti alla stampa del presente listino su catalogo. Vi facciamo presente che il nuovo listino è da ritenersi suscettibile di riedizioni in funzione dei continui ed inaspettati aumenti dovuti alla situazione di mercato.

Prezzi

I prezzi riportati nel presente catalogo sono al netto di IVA e si intendono per merce franco Ns. magazzino. **La ditta si riserva il diritto di apportare variazioni al presente listino senza alcun preavviso**. Ai clienti è riservata la modalità di pagamento concordata con la LEGAR entro la linea di fido concessa. Per i nuovi clienti le spedizioni arriveranno in contrassegno fino a quando non sarà costituita una linea di fido. I prezzi esposti si intendono cadauno, oppure per paio, kit o confezione dove specificato.

Minimo d'ordine

Minimo d'ordine € 100,00.

Per **spedizioni** con importo inferiore, **pagamento con bonifico anticipato**

Spedizioni

Le spedizioni vengono eseguite franco nostro magazzino. **La merce viaggia a rischio e pericolo del committente, anche nel caso fosse venduta franco destino**. La LEGAR pertanto non è responsabile di eventuali ammanchi o danni di qualsiasi natura che si verificassero durante il trasporto e, tanto meno, è responsabile di eventuali ritardi dovuti al vettore. Tutte le spese derivanti da ritardato pagamento o mancato svincolo di merce regolarmente ordinata, saranno a carico del cliente inadempiente. Le spese di trasporto verranno addebitate in fattura. I corrieri sono scelti dalla LEGAR.

Consegne

I termini massimi di consegna sono da intendersi approssimativi. In caso di interruzioni o impedimenti nella produzione non dovuti alla volontà della ditta LEGAR, la consegna di quanto non ancora prodotto verrà annullata senza che il compratore abbia diritto a richiedere alcun risarcimento, inoltre il compratore sarà tenuto comunque ad assolvere regolarmente al pagamento di quanto in precedenza consegnato.

Modalità di Pagamento

I pagamenti dovranno essere effettuati al domicilio della LEGAR o a persone dalla stessa autorizzate. Il mancato pagamento delle fatture alle scadenze stabilite autorizza la LEGAR ad emettere note di addebito per interessi di mora nella misura pari al tasso bancario in vigore più spese generali pari a € 7,00. Inoltre si riserva di annullare la parte di fornitura non ancora eseguita e di richiedere l'immediato pagamento della parte già consegnata.

Resi merce

Vi ricordiamo che per i resi merce è indispensabile attenersi alle seguenti modalità:

A) contattare i Ns. uffici o l'agente di zona e concordare l'autorizzazione al reso;

B) effettuare il reso in porto franco a mezzo corriere;

C) il soggetto che effettua la restituzione dei beni deve emettere:

DDT con causale: "reso merce", specificando nello stesso gli estremi della fattura acquisto dei beni restituiti.

Se non saranno osservate queste disposizioni LEGAR non potrà emettere la nota di accredito.

Non saranno presi in considerazione resi di merce effettuati dopo un anno dall'acquisto.

Non potranno essere accettati resi di merce, reclami, richieste di sostituzione o rimborsi, per gli articoli manomessi, stampati o personalizzati.

Controversie

Per tutte le controversie che non possono essere risolte amichevolmente il tribunale competente è il foro di Brescia.





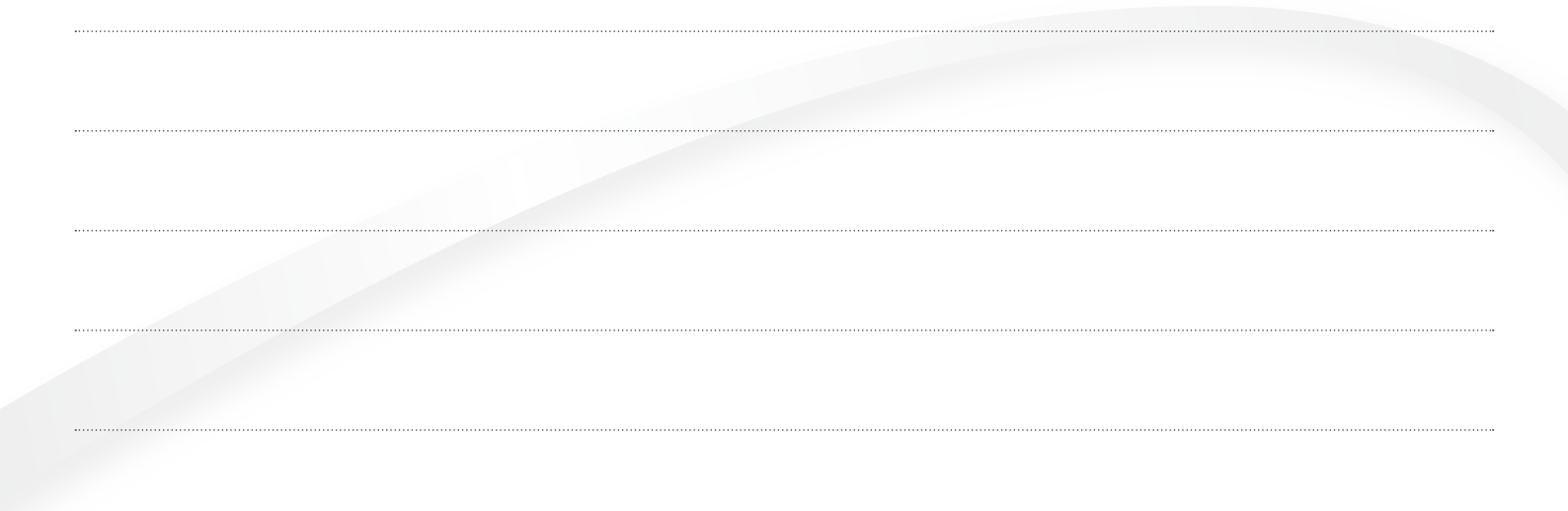

LEGAR



ANNIVERSARY

30

1996 — 2026

LEGAR SPORT S.R.L.
Via degli Artigiani, 42
25020 Bassano Bresciano (BS) - ITALIA
Tel. +39 030 9935551